

PHASE**ONE**

what the world's best photography is made of

XF IQ4 Camera System User Manual



Content | XF IQ4 Camera System Manual

Primary parts of the XF IQ4 Camera System	4		
Lens, XF Camera Body, IQ4	4	Using the Status Bar	33
		Status Menu	34
		Camera Controls	34
		Live View	34
		Changing settings in Tools	35
		Four Key Navigation	35
Dials, Buttons and Touch Screen Interface	6		
XF Camera Body	6		
Top Touch Screen, Dials and Keys	7		
Assembling the XF IQ4 Camera System	8		
Digital Back and Camera Body Modularity	8	Viewing Images	36
Attaching the IQ4 to the XF Camera Body	8	Viewing single Images	36
Attaching a lens	9	Delete a single image	36
Interchangeable Viewfinders	9	Rating an image	36
		Displaying a Histogram	36
		Image Info	37
		Exposure Masks	37
		Setting a Custom White Balance	37
		Viewing Images as thumbnails	38
		Deleting multiple images	38
		Browser Image Info	38
		Browser Exposure Masks	39
Readying the camera system	10	Camera Controls	40
Charging the batteries	10	Selecting the Exposure Program	41
Charging a device by USB	10	Setting the White Balance	41
Loading and removing the batteries	12	XF Camera settings	41
Setting Date, Time and Language	13	Using Autofocus and capturing an image	41
Security Code Protection	13	Virtual Horizon Tool	42
Installing an XQD card	14		
Installing a SD card	14	Tools Viewer	43
Removing an XQD card	14	Using the Tools Viewer	43
Removing a SD card	14	Histogram	44
Selecting cards for storage	14	Exposure and Clip Warning	44
		Exposure Zone	45
		Displaying a Grid	45
Navigating the XF Camera System	15	Live View	46
Top Touch Screen	15	Activating Live View	46
Three dials and two keys	15	Exposure Simulation	47
Camera menu	15	Using Auto Gain for Automatic Brightness	47
User configurable buttons	15	Live RGB and RAW Histograms	48
XF Camera Body Controls	16	Live RAW Clip Warning	48
		Focus Peaking	48
		Displaying a Grid	49
		Manual Focus in Live View	49
		Setting a Custom White Balance	49
Customizing buttons and dials	19	Live View over HDMI	50
Changing the function of a dial or button	19	Connecting HDMI	50
		Enabling HDMI Output	50
		Display Histograms and Clip Warning	50
		Display Focus Peaking	50
		Showing the IQ4 UI over HDMI	51
OneTouch User Interface Flow Diagram	21	Security Settings	52
XF Camera Menu Overview	21	Changing Security Level	52
		Locking the IQ4	52
		Creating a new Security Code	53
		Recovering a locked IQ4	53
		Tethering Access Code	53
OneTouch User Interface Overview	23	File formats and IQ Styles	54
XF Camera Body Navigation	23	RAW file formats	54
Dials	23	Fast, prerecorded Black Reference Frame	56
Top Touch Screen Operation	23	Enter your Copyright information	56
User Control Buttons	23		
Front and Rear Keys	23		
Top Touch Screen Layout	24		
Auto Functions on Shutter Speed, Aperture and ISO	25		
XF Tools on the Top Touch Screen	26		
HDR Tool	26		
Timelapse Tool	27		
Focus Stack Tool	27		
Hyperfocal Tool	28		
Focus Trim Tool	29		
Profoto Remote Tool	30		
Seismograph Monitor	30		
BullsEye Level Tool	30		
Flash Analysis Tool	31		
Vibration Analysis Tool	31		
Capture Analysis Popup	31		
IQ4 Navigation	32		
Touch Screen Operation	32		
Accessing Tools, Settings and Status	32		
Using the Shortcuts Menu	33		

Content | XF IQ4 Camera System Manual

File Storage Setup	57	Delayed	85
File Storage overview	57	Manual (Bulb/Toggle)	85
Storage Mode	57		
SD card Storage options	58	XF Camera System Exposure Modes	86
Saving a jpeg version	58	Changing the Exposure Mode	86
Saving a RAW backup on the SD card	58	Auto ISO Setting	86
Formatting the memory cards	58	OneShot AE Exposure Mode	86
Tethering Connections	59	Exposure Compensation	88
Gigabit Ethernet connection	59	Using Exposure Compensation	88
Ethernet Cables	59		
USB-C connection	60	Long Exposure	89
USB-C Cables	60	Noise Reduction (Dark Frame Subtraction)	89
Wireless connection	61		
Connection for WiFi tethering	61	Electronic Shutter (ES)	90
Managing Known WiFi Networks	62	Enabling the Electronic Shutter	90
		Using Electronic Shutter (ES) without the XF Camera Body	91
Power Connections	63	Self Timer Delay	91
Power over Ethernet (PoE)	63	Prerecorded Black Reference Frame	91
Power over USB-C	63	Enable Antiflickering	92
Using a USB-C Power bank	64		
External XF Power Supply	64	Flash Photography	93
Power input priority for the XF IQ4 Camera System	64	Profoto Remote Tool	94
Power Management Options	65	Enabling Profoto Air Sync and Air Remote	94
Hot swapping batteries on the XF IQ4	65	Using the Profoto Remote Tool	94
		Triggering a Capture with the Profoto Remote	95
Custom White Balance	67	Flash Analysis Tool	96
Saving the Custom White Balance automatically	67	Rear Curtain sync and Trim	96
		Shutter Mechanisms and Flash Synchronization range	97
Prism Viewfinder Display and Functions	68		
Autofocus Area	68	XF Camera System Lenses	98
Viewfinder Display	68	Focal Plane and Leaf Shutter Lenses	98
Eyepiece Diopter Adjustment	69		
		Capture One Pro	99
XF Camera System Settings Overview	70	System requirements	100
Shutter Speed	70		
Aperture	70	Capture One Tethered Use	102
ISO Selection	70	Shooting Tethered	102
AF/MF	71		
AF Drive Mode	71	Capture Pilot	104
AF Area Mode	71	Using Capture Pilot	105
Capture Mode	71		
Exposure Mode	71	Lens Cast Calibration	106
Metering Mode	71		
		XF Custom Presets and IQ4 System Backup	109
Honeybee Autofocusing System	72	XF Camera Body Custom Presets	109
Focus Modes	72	Save and Load System Setup	111
AF Area Modes	73		
AF Compensation with Focus Trim	75	System Maintenance	112
		Keeping your XF Camera clean	112
Focus Trim Tool	76	Cleaning the Sensor on IQ Digital Back	114
		Updating the XF IQ4 System Firmware	116
Autofocus & Recompose mode / AFR Mode	79		
Enable AFR Mode	79	Learning More	122
Feedback on focus accuracy	80	Phase One Customer Service	122
		Phase One Technical Support	122
Working with hyperfocal distance	82		
Hyperfocal distance on the XF Camera System	83	Phase One Information	123
		Warranty and Uptime Guarantee	123
XF Camera System Capture Modes	84		
Single capture	84	General Conditions	124
Continuous capture	84		
Vibration Delay	84	Notices	125
Exposure Bracketing	84		

Primary parts of the XF IQ4 Camera System

Lens, XF Camera Body, IQ4





Dials, Buttons and Touch Screen Interface

XF Camera Body

Shutter release buttons and user buttons are all positioned within reach of your fingers. These are all used for photography applications and are referred to as “buttons” as opposed to “keys” which are the user interface keys designed to control the user interface on the OneTouch UI described later in this manual.



Top Touch Screen, Dials and Keys

The top screen of the XF Camera Body has a touch-sensitive transfective LED display, providing a mix of direct access to features as well as a menu system navigated using the dials and keys. All the controls are customizable.



Assembling the XF IQ4 Camera System



Digital Back and Camera Body Modularity

Depending on how you purchased the system, the XF Camera System may be supplied ready for use with the IQ4 Digital Back already attached, and consequently, there is no need to remove it prior to capture. If, however, you would like to do so, for example, to use it with a technical camera, please follow the instructions below.

Removing the IQ4 from the XF Camera Body

1. Turn the Camera System off and remove any interface cables from the Digital Back.
2. Push the IQ4 lock slider toward the XF Camera Body while simultaneously pressing the IQ4 release button. Note that the lock slider acts as a safety catch.
3. Tilt the IQ4 slightly backward from the top and gently lift the IQ4 off the XF Camera's guide rail.

NOTE:

After removing the IQ4 from the XF Camera Body, remember to protect the sensor by reattaching cover, and to attach the back port cover on the XF to protect the camera from dust.

Attaching the IQ4 to the XF Camera Body

1. Gently place the mounting plate of the IQ4 onto the bottom guide rail of the XF Camera Body.
2. Push the back lock slider and press the release button simultaneously to retract the back's upper locking mechanism, and then push the IQ4 firmly onto the camera's twin catches, using the bottom guide rail as a pivot.

Removing the lens

1. Press the lens release button on the right-hand side front of the camera and keep pressed.
2. Rotate the lens counter-clockwise on the body until it stops, and lift it out carefully from the body.

Attaching a lens

1. Looking down from the top of the camera, or from right hand side, align the blue or the red index point on the lens with the blue or red index points located on bayonet mount of the XF Camera Body and rotate clockwise on the body until it stops and clicks into position.

Two different colored index points are available to allow easier attachment of the lens to the camera. Either when looking downwards from above the camera (blue), or in front of the camera looking from the side (red).

If you are not replacing with another lens, then reattach the front and rear caps, and keep them always attached to the body to protect the mirror-mechanism or lens elements from accidental damage.

Interchangeable Viewfinders

In addition to the Prism Viewfinder, the XF features an optional Waist Level Finder (Part # 73090).

Removing the Viewfinder

1. Ensure the power of the XF Camera System is Off.
2. Grasp the viewfinder securely with your right-hand and push the viewfinder release slider forwards, towards the lens with the right thumb.
3. Lift the viewfinder up and out carefully, beginning with the rear of the viewfinder then moving up and away from the camera body.

Attaching the Viewfinder

1. Ensure the power of the XF Camera System is Off.
2. Hold the viewfinder securely with your right hand, with the viewfinder tilting downwards slightly.
3. Place the front edge of the viewfinder so that it is resting on the front edge of the body.
4. Ensure that the viewfinder's front locating pins are aligned with the body's pin registration recesses, located in the front of the XF Viewfinder port. (Both the electrical contacts and prism of the viewfinder must be aligned with the body's contacts and viewfinder screen recess.)
5. Carefully lower the rear of the viewfinder until level with the body, then press the viewfinder down firmly until it clicks into place.

NOTE:

Ensure the viewfinder is securely attached before turning the power on and using the camera. Failure to ensure the viewfinder and body are properly secured could result in a camera malfunction. There is also a risk of dropping either the camera or the viewfinder if the viewfinder is not securely attached! Always remember to protect the optical elements.

XF Waist Level Finder Diopters

You can replace the default magnifier lens of the XF Waist Level Finder with an optional Diopter and use the finder without eyeglasses in case you are nearsighted or farsighted. Each Waist Level Finder Diopter has a fixed correction value, for example minus two (-2), whereas the default magnifier is neutral (zero correction).

The Diopters are accessories and can be ordered by using these part numbers:

- 73094 XF Waist Level Finder Diopter +2
- 73095 XF Waist Level Finder Diopter +1
- 73096 XF Waist Level Finder Diopter 0 (Included with the WLF)
- 73097 XF Waist Level Finder Diopter -1
- 73099 XF Waist Level Finder Diopter -2

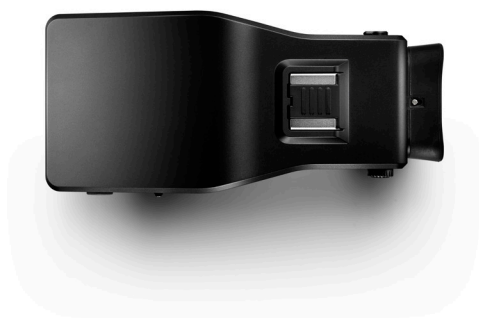

Readying the camera system



Charging the batteries

When working untethered, the standard power source of both the XF Camera Body and IQ4 back is the 7.2 V (3400 mAh) BP-911/914/915 type rechargeable Li-ion battery.

To maximize battery performance, charge both batteries before use with the supplied Pro Cube 2 charger. Approximately 2.5 to 3 hours are required to fully charge exhausted batteries.



1. Connect the supplied power adapter to the charger and insert the batteries into the charger slots. If charging only one battery, either slot can be used.
2. The charge indicator will blink and display the battery's approximate capacity as a percentage.
3. Charging is complete when the charge indicator stops blinking and the capacity level displays "100%".
4. Remove the batteries and unplug the cable from the charger.

The Pro Cube 2 will display how much the batteries have been charged in mAh since the charging session started. This can be useful if you are in a hurry and know from experience that a particular amount of mAh is enough to get you 100 captures, for example. The three dots over a battery icon indicates on the display which one is currently being measured.

Dual battery system

The XF Camera Body and the IQ4 use identical 7.2 V (3400 mAh) BP-911, 914, 915 type rechargeable Li-ion batteries and share the same charger for convenience, however the IQ4 requires a battery to be loaded prior to use, also when working tethered to a computer using a bus-powered interface cable (Gigabit Ethernet or USB-C).

XF and IQ4 Power Sharing

The XF Camera Body and IQ4 are designed to share power from the two BP-915 type batteries in the system, thereby providing improved operation time for the full system. Make sure the feature is active on the IQ4 by setting **Power Management > Power Share With Camera** to **On** in the IQ4 Menu.

Charging a device by USB

The XF Pro Cube 2 can also be used to charge a device like a smartphone by connecting it to the USB port on the charger. The display will show USB when doing so. Note that the Pro Cube 2 will charge any inserted Li-ion batteries fully before starting to charge the attached device over USB.

General advice for the battery and charger

Charge the batteries before use

Batteries discharge when not in use. For optimum performance, charge the batteries before using the XF Camera and IQ4 .

NOTE:

In low temperatures, keep spare batteries close to body temperature by storing in an inside jacket pocket. Li-Ion type batteries tend to lose efficiency under cold conditions.

Charge the batteries indoors

Only charge the batteries indoors (and away from moisture) at ambient temperatures between 5-35 Celsius (41-95 Fahrenheit).

Remove batteries when not in use

Never leave the battery in the charger for an extensive period of time. When charging is complete, remove the battery and unplug the charger from power outlet. When the battery is left in the XF Camera Body or the IQ4 a small amount of current is drawn, resulting in accelerated discharge and shorter battery life. Remove the batteries when not in use.

Only use approved batteries

Use only 7.2 V BP-915 type batteries. Capacity in excess of 3300 mAh is recommended. Some third party batteries may not fit into the XF Camera Body or IQ4's battery compartment, due to differences in the manufacturing tolerances. Do not try to force a battery into the compartment. When pressing the battery release button it should slide out without being hindered. If a battery can't be removed, levering the battery out may cause damage. Please contact your Phase One dealer for advice.

Dirt and fingerprints on battery terminals may cause loose connection and corrosion. Clean the contacts with a soft-cloth before loading the batteries.

Shooting tethered

Always keep a battery in the IQ4 when shooting tethered to a computer via a Gigabit Ethernet or USB-C connection. Please read the Power Connections chapter for more information.

Use in foreign countries

The AC power adapter is supplied with several power plug adaptors for international use. The power adaptor is compatible with 110 to 250 V AC (50/60 Hz) power sources.

Only use the original power adapter or 12 V DC car adapter (supplied)

It is not recommended to use a portable voltage transformer with the battery charger. Battery charging from a car's 12 V electrical socket is possible but the car battery will discharge if the engine is not running.

Powering On and Off from the XF Camera Body

Powering up both the XF and the IQ4 simultaneously is achieved with a short press of the On/Off button located on top rear of the grip on the the XF Camera Body. A long press of the same button will power off the XF. The IQ4 will follow and power-off automatically after a few seconds. The XF and IQ4 may also powered on and off from the IQ4, using the back's power button.

NOTE:

There can be a low number of shutter actuations reported on a brand new XF Camera Body or Leaf Shutter Lens. This is normal behavior as the shutter mechanism has been tested during final quality check procedures. The shutter count on a new XF Camera Body or Leaf Shutter Lens should never exceed 99.

For a Certified Pre-Owned Camera System that includes a physical shutter (Leaf Shutter Lens, XF Camera Body) or recorded digital capture count (Digital Back), the actual capture count should never exceed 5,000 actuations.



Loading and removing the batteries

Loading the battery in the XF Camera Body

1. Open the battery compartment cover located in the base of the XF Camera Body grip.
2. Insert the battery with power contacts first.
3. Push the battery up until it locks into position.
4. Close the battery compartment cover.

Removing the battery from the XF Camera Body

1. Open the battery compartment cover.
2. Push the metal retaining catch inside the grip to release the battery and pull out.
3. Close the battery compartment cover.

Loading the battery in the IQ4

1. Open the battery cover located on the underside of the IQ4 .
2. Insert the battery, power contacts first.
3. Push the battery up until it locks into position.
4. Close the compartment cover.

Removing a battery from the IQ4

1. Open the battery compartment cover.
2. Push the retaining catch inside the compartment to release the battery and pull out.
3. Close the battery compartment cover.

Battery life

The actual number of shots possible will vary depending on the shooting conditions. For instance Image Browsing, Autofocus operation, Live View, WiFi and Profoto Air use will reduce the number of shots available on a single charge. The age and condition of the battery also has an effect on battery life.

Setting Date, Time and Language

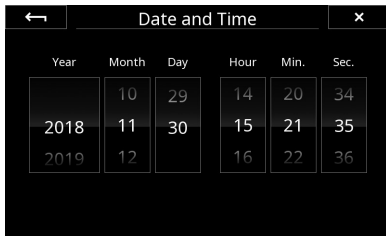

Setting the Date and Time on the IQ4

Date and time are set and controlled via the IQ4's menu. When the IQ4 is initially shipped from factory, or if the IQ4 has been without power for a long period of time, it will automatically prompt you to set the time and date. Touch the screen and scroll through the numbers to attain the appropriate date and time. The time and date is applied to the EXIF data in all files captured with the IQ4. You can change this later in the Menu under **IQ Settings > Date and Time**.



Setting Language on the IQ4

The XF IQ4 Camera System is delivered with the language set to English by default. Follow the steps below to change the language of the IQ4 to one of eight others available, including German, Russian, Korean, Japanese, Chinese (simplified), Swedish, Italian and Spanish.

Swipe up from the bottom of the screen and tap on the IQ4 Menu icon. Navigate to the **Language** menu item and select the preferred language option. Each choice is displayed using the native language, with English noted in parentheses.

Note: If you choose a language by mistake, and can no longer read the menu, look for the menu item with **(L)** in it.

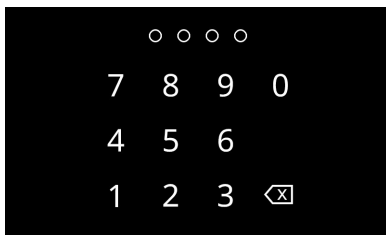

Security Code Protection

Access to the IQ4 can be protected by a four-digit security code that you will have to enter on the touch screen after it has been turned on.

The security code protection is a safety measure to ensure that other people cannot gain access to the IQ4 without your consent. This is of particular importance since IQ4 can provide wireless access over a network that other people might have access to.

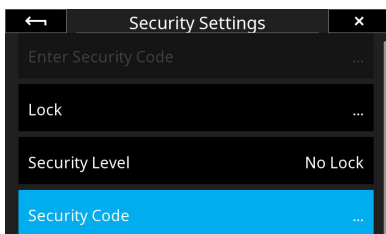

You can setup the security code as well as the level of protection by selecting **Menu > Security Settings** on the IQ4. Please see the Security Settings chapter later for full details.

Using memory cards

The Phase One IQ4 supports both XQD and SD memory cards. Phase One recommends that you use the supplied Sony XQD G Series 64 GB card or a similar card with the same 400 MB/s write speed rating for optimal performance.

The SD card slot supports both the fast UHS-II and the slower UHS-I standards. If you plan on saving raw files to the SD card, use the supplied Sony SDXC UHS-II G Series 64GB card as it is based on the fast UHS-II standard, or use a similar card with the same UHS-II speed rating.

Note: While the XQD card slot in the IQ4 is compatible with CFexpress cards from a mechanical stand point, CFexpress cards are not supported yet. A future firmware upgrade for IQ4 is planned to add support for CFexpress cards.



Installing XQD and SD cards

Installing an XQD card

When inserting the XQD card into its media storage slot in the IQ4, make sure that the labeling side on the card is facing towards the front of the back so that the small triangles on the XQD card and the IQ4 XQD slot align. Slide it straight into the slot until it clicks into place. If resistance is felt, stop immediately, and check whether the card is oriented correctly.

Installing a SD card

Position the SD card so the label is facing towards the screen on the IQ4 and slide it straight into the SD marked-slot until it clicks into place. You will need to push the SD card into the port until it is recessed about 1 mm to ensure it locks into place. You will hear a click once that point has been reached. If resistance is felt, stop immediately, and check whether the card is oriented correctly.



Removing the SD card

Removing an XQD card

Before removing the XQD card, confirm that the memory card access light is off. Then press the card in with a finger to release it. The memory card pops out and can be removed by using two fingertips.

Removing a SD card

Before removing the SD card, confirm that the memory card access light is off. Then press the card in and let it go. The inserted SD card needs to be pushed about 1 mm into the port before it will release. Use a small plate or a finger nail to do so. The memory card will now be released, and you can remove it with your fingertips.

Selecting cards for storage

You can choose to store the captured raw files on either the XQD or the SD card. You also have the option to save a raw version to XQD and a jpeg version to SD. It will be explained in a later chapter how to set this up.



LED Lights

LED Lights

The IQ4 feature two main LEDs located below the bottom left corner of the screen.

A **Blue** LED will show when you power the IQ4 on. Two **Red** LEDs indicates that the back is going through the boot up procedure.

When capturing an image the **Green** LED will blink rapidly to indicate that the IQ4 is busy and that there are images in the buffer that needs to be cleared to the XQD card, the SD card and/or the local storage.

A **Red** LED indicates that the IQ4 is writing to the storage media, and therefore the buffer has not been emptied.

Restoring the defaults

The IQ4 is supplied preconfigured with a number of default settings ready for use, either when purchased by itself, or with the XF.

After adjustment of these settings, you can restore the back to the factory defaults from the back's screen by pressing **Menu > System Settings > Restore to Default**.



Restore to Default

Navigating the XF Camera System

Introduction to the Top Touch Screen, Dials, Keys and XF Camera Menu

Top Touch Screen

Central to the operation of the Phase One XF Camera System is the XF Camera Top Touch Screen. Sitting at the top of the large, ergonomic hand-grip this touch-sensitive, multi-functional screen displays the camera's essential settings, keeping you fully informed at all times. Access to all of that information is quite literally at your fingertips.

Not only does the Top Touch Screen allow you to make selections on the fly but also falling naturally under the fingers and thumb of your right hand are all the controls required to take command of the camera. To change the Exposure mode, AF mode or Metering mode, or switch between manual ISO and Auto, just touch what you want to adjust on the screen and select from the choices displayed.

Three dials and two keys

The XF Camera Body is designed with a dedicated, ergonomically placed dial for each of the exposure settings; Shutter Speed, Aperture value and ISO. The dials are highly customizable allowing, for instance, any one of them to be reconfigured to alter exposure compensation in Av/Tv or Program, this gives you direct control of the exposure mode.

The dials are modal, switching their function to navigate the Top Touch Screen's integral menu system, or to scroll through each of the displayed function settings as a shortcut, depending on which mode is selected. A single press of one of the two aluminum Top Keys is all that's required.

The Front Key accesses the touch screen's shortcut Camera Function mode, while the Rear Key is used to reveal the integral Camera Menu.

Camera menu

In the menu system, the Front Dial is always used to scroll up and down through the options, while either the Rear or Side Dial is used to navigate to the next level and ultimately to select settings. That can't be changed to avoid confusion, but we've made the Top Front and Rear Keys modal and they're customizable as well. You can move up and down the menu with either set of controls or reconfigure the keys to move between levels, but you'll still need to make selections using the Rear or Side Dial.

User configurable buttons

None of the buttons are labelled, as the features they access are customizable. The Secondary Shutter Release Button, for example, located at the front of the camera, and two the User Buttons, are easily reconfigured from the Top Touch Screen's Camera Control menu.

Once a function has been chosen, a simple half press of the shutter button is all that is required to return the camera to full readiness, so you'll never miss a shot. The only time you will be asked to confirm the settings is when storing or loading groups of settings in one of the three Custom modes, or when restoring the camera to the default (factory) settings. No further confirmation of the settings is necessary, meaning that you can rest assured, the settings are always stored when leaving the menu system.



XF Camera Body Controls

NOTE:

If AF priority is set to "Focus", the camera will only capture an image if the AF system obtains focus.

Shutter Release Button

The shutter release button has a two-stage operation: the first is accessed by a gentle half press and activates both the exposure meter and auto-focus. Pressing the button all the way down to the second stage trips the shutter, either immediately in Single, Continuous Shooting or Exposure Bracketing modes, or after initiating a certain action, such as focusing or locking the mirror up for the Vibration Delay (self-timer) mode. If the camera is in Display Off (sleep) mode, a half press will wake up the camera and activate any configured functions. Half press the shutter release can also be used to exit menus and to return the camera to instant readiness.



Secondary shutter release button

This modal button is de-activated by default but when the shutter release function is enabled (from the Top Touch Screen menu), the secondary shutter release button replicates the functionality of the main shutter release button. When enabled, the primary shutter release button remains active, and either button can be used to release the shutter, or initiate a chosen action.

Top Touch Screen

As a multifunction panel the screen layout varies depending on the status of the camera. However, the Classic layout is the main display, and it's here that the camera's exposure values and mode settings are displayed. Shutter speed, ISO and Aperture values are selected directly by the Front, Rear and Side Dials, respectively. Other camera functions, depicted by icons, including capture, metering and AF area modes may be selected quickly via the optional Camera Function settings mode, after pressing the Front Key and scrolling through the options using the Front Dial, or via touch. The Camera Menu display is used to select the less commonly used camera functions. It is accessed via a short press of the Rear Key, and navigated using the Front Dial. Options are chosen using the Rear and Side Dials.



Top Touch Screen

Note the brightness of the Top Touch Screen is determined automatically using a sensor close to the screen, however the brightness setting can be altered via the Rear Key > UI Setup > Backlight



Front Dial

Front Dial

This is used to adjust the Shutter Speed by default, however it is modal, and after pressing the Front or Rear Key it is repurposed for navigation of the Camera Function settings and the Camera Menu, respectively. Note the Front Dial is customizable.



Rear Dial

Side Dial

Side Dial

This is set-up to adjust the Aperture value by default, and is similarly repurposed for making selections from both the Camera Function settings and Camera Menu via the Top Touch Screen. The Side Dial is customizable.

Rear Dial

This dial is principally used to adjust ISO, and like the modal Side Dial, is also used for making selections from both the Camera Function settings and Camera Menu. The Rear Dial is also customizable.



Rear button

Front button

Top Front Key

A short press on the Front Key activates the camera function icons displayed on the Top Touch Screen for quick selection, either by repeated pressing of the key or scrolling with the Front Dial. Note the selection is highlighted in white. Adjustment is made using either the Rear or Side Dial and the depicted function is active immediately.

Top Rear Key

A short press and release of the Rear Key will gain access to the camera menu. When the menu is displayed on the top touch screen, the Rear Key's function is repurposed for navigation and can then be used to scroll down through the menu options (with the Top Front Key used to scroll back up). Note the Front Dial can be used to scroll up and down the menu instead.



On/Off Button

On/Off button

A quick press will power up the camera. The XF start-up logo appears on the Top Touch Screen, followed by the Classic display. If the power level is too low, the battery warning light will flash continuously in red. Otherwise if battery power is sufficient, the warning light stops and the mirror can be heard lowering into position, ready for capture. This behavior is normal, as the mirror is automatically locked up when powered off for peace of mind during transportation. If left untouched, the camera will enter the Display Off (sleep) mode after 1 minute. Simply half press the Shutter release Button to reactivate the display and ready the camera for capture. Note, the delay for the camera to enter the Display Off (sleep) or Mirror Position are all customizable via the Rear Key > Power Management.

The On/Off button is modal and a quick press while in the camera menu will return it to the previous level, including exiting the menu altogether if pressed when navigating the menu at its upper level.

To power the camera down, press and hold the button for 2 seconds. The mirror can be heard being locked safely in position and the IQ back will power down after 3 seconds.



Front User Button

Front User button

This button is by default set to activate the depth of field function. Note continued pressure on the button is required to operate this particular function, but the modal nature of this button means some functions accessed via this button require only a single press and release, for example, when reconfigured for AF-Lock and AE-Lock.



Rear User Button

Rear User button

From the factory the Rear User button is programmed to activate the camera's AE-L (Auto Exposure Lock) function, locking meter readings made in Auto and Manual exposure modes. The Rear User button is customizable,



B.O.B - Cable Release accessory

External shutter release control (B.O.B)

The XF Camera System gives you the option to customize the functionality of the Phase One Break Out Box accessory. This is done by pressing the rear user key and selecting UI Setup > Control Setup > External.

By default it works like a shutter release button, but a particularly useful feature is the ability to activate the two-step mirror control and shutter release instead.

This will make the external button — the B.O.B release button — act with a two shot mirror up function, raising the mirror on the first press, and shooting on the next. You activate the feature by selecting UI Setup > Control Setup > External > MUP-Exp.

Rear	Auto Focus
Front	AEL Toggle
2nd Shut.	Mirror Up
External	MUP-Exp.
Menu Btns.	Up/Down

Mirror Up and Exposure action with External



Customizing buttons and dials

You can customize the functionality of the buttons and dials on the XF Camera to suit your preferred workflow. For example, you might want to control auto focus separately from the shutter release button, or activate Mirror Up or Live View with the push of a button. At the end of this section you will be guided on how to setup some of the most useful customizations.

You can customize all of these buttons and dials on the XF Camera:

- Shutter Release Button (only for the half press action)
- Secondary Shutter Release Button
- Front Dial
- Side Dial
- Rear Dial
- Front User button
- Rear User button
- External Shutter Release (B.O.B.)

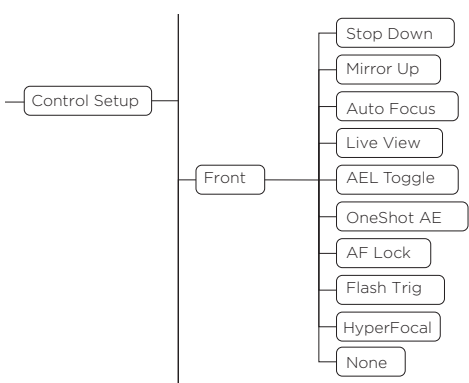

The OneTouch User Interface Flow Diagram section in this XF Manual will show you exactly which functions or actions that can be assigned to each button and dial. Follow the path Rear Key > UI Setup > Control Setup in the diagram and note that the top option in a list is the default setting.

It is worth pointing out that the Front Dial, Side Dial and Rear Dial both have a Primary and an Auto option. Most of the time, the XF Camera will use the assigned Primary option, and the Auto option only comes into play when you are using one of the automatic exposure modes; Aperture Priority (AV) or Time Priority (TV). If you are using Aperture Priority (AV), for example, the Side Dial will control the aperture value and you can then assign the Front Dial to control the Exposure Compensation value. The Auto function can only be set to either control the Exposure Compensation value or engage the Focus Nudge feature.

Changing the function of a dial or button

Press the Rear Key and select UI Setup > Control Setup. Then select the button or dial that you want to customize, and turn the Side Dial until you have selected the desired functionality.

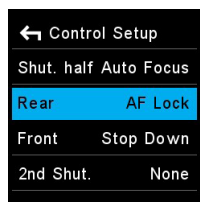

Changing the Control Setup.

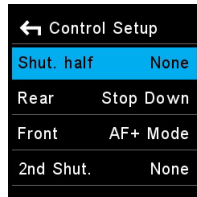

Changing the shutter half press action to None.

Remove auto focus from the Shutter Release button

It can be very useful to control auto focus separately from triggering the shutter. With such a setup, you can focus at a certain point of the subject and then take multiple captures by pressing the shutter button repeatedly without having to worry about the camera requiring focus each time.

By default, auto focus is activated by pressing the Shutter Release Button halfway down, so you need to remove this functionality. This is done by pressing the Rear Key and selecting UI Setup > Control Setup and selecting Shut. Half. Then turn the Side Dial until None is selected.



Adding auto focus control to the Rear User Button.

Add auto focus to the Rear User button

If you have removed auto focus from the Shutter Release Button, you need to assign the functionality to another button on the XF Camera. The most convenient to use is the Rear User Button, but you can also assign auto focus to the Front User Button, the Secondary Shutter Release Button or External Shutter Release (B.O.B.).

Auto focus is assigned by pressing the Rear Key and selecting UI Setup > Control Setup and selecting Rear. Then turn the Side Dial until Auto Focus is selected. Auto focus is now activated each time you press the Rear User Button and is in effect locked once you let go of the button.

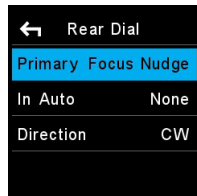

Adding Focus Nudge to the Rear Dial.

Add Focus Nudge to the Rear Dial

If you are working with a very narrow depth of field, it can be difficult to adjust focus with the necessary precision by focusing the lens manually. The Focus Nudge feature is a great way to get accurate focus control, and you just need to assign the feature to one of the three dials to activate it.

It makes the most sense to use the Rear Dial as the Front Dial and Side Dial is used to control the shutter time and aperture. You assign the Focus Nudge feature by pressing the Rear Key and selecting UI Setup > Control Setup > Rear Dial > Primary. Then turn the Side Dial until Focus Nudge is selected.

The Focus Nudge feature is sensitive to the speed with which you turn the dial, so moving it faster will move the focus more than turning the dial slowly. Focus Nudge works particularly well when using live view where you have zoomed in at the point of focus.

Note that the Rear Dial is set to control ISO by default, so you need to change the ISO value another way. This can be done by tapping the Top Front Key until the ISO value is selected and then adjusting the ISO value with the Side Dial.

OneTouch User Interface Flow Diagram

XF Camera Menu Overview

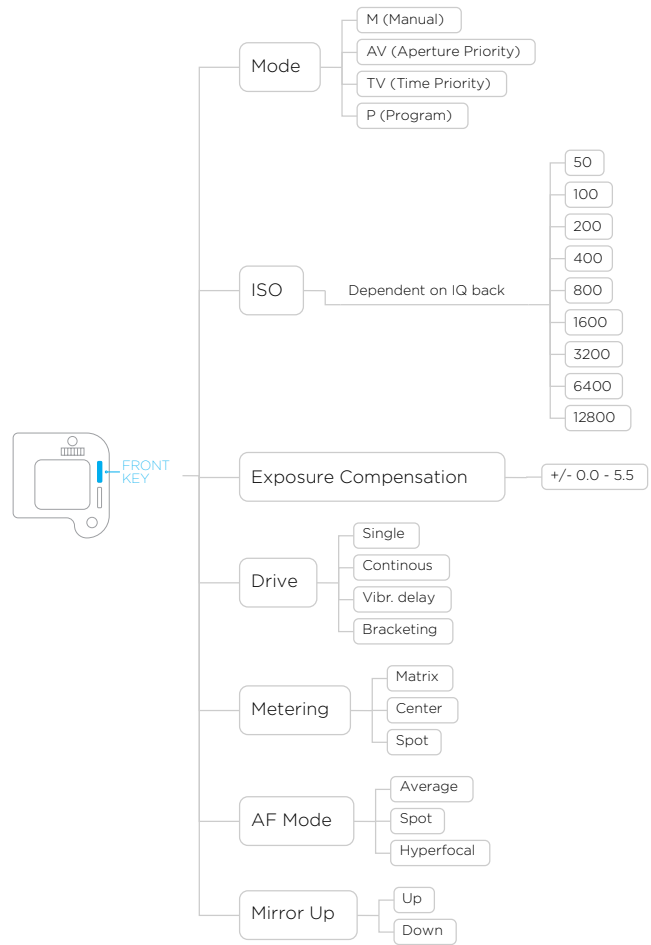

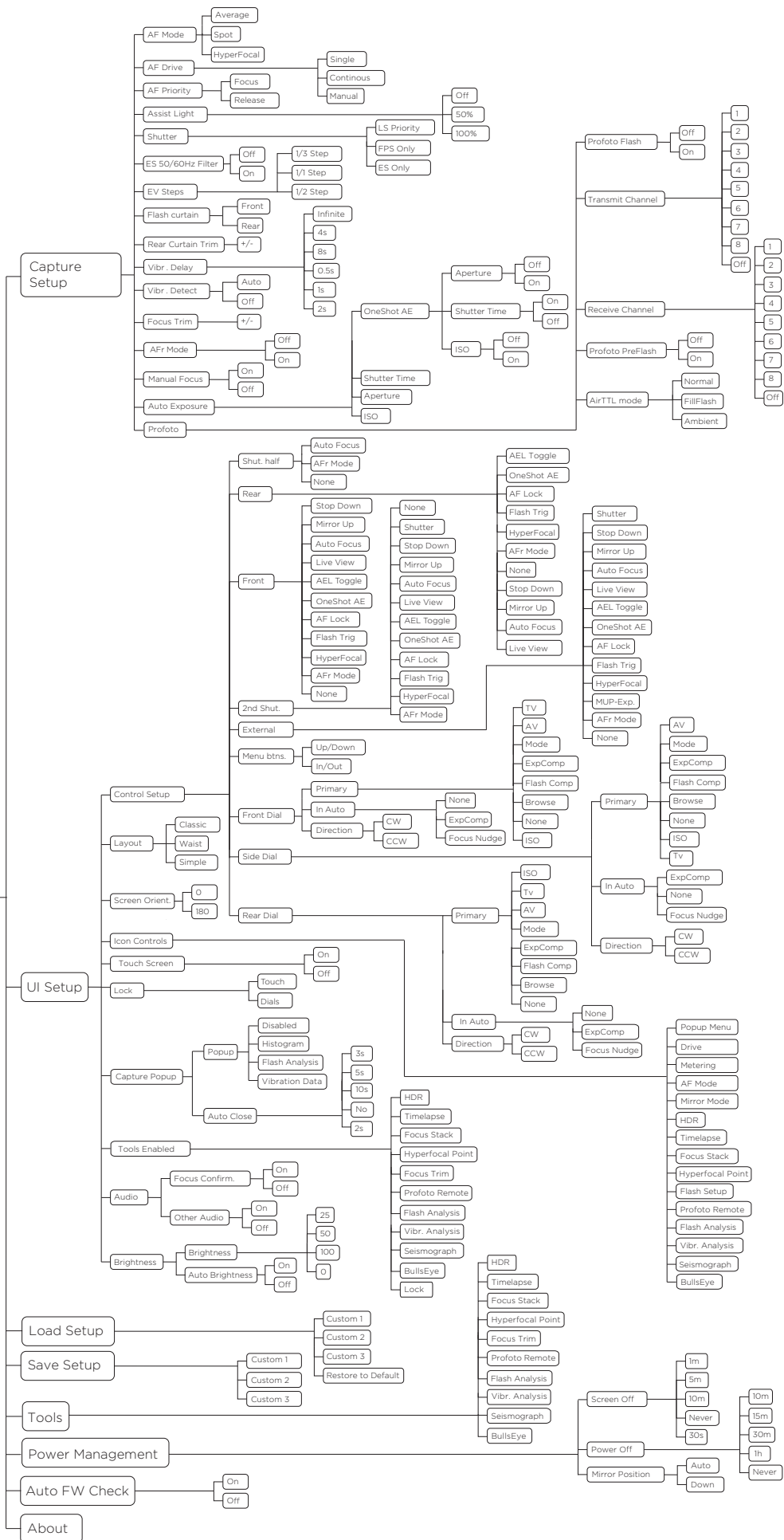
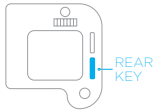

OneTouch User Interface Overview

XF Camera Body Navigation



Top Touch Screen Operation

Dials

The XF Camera System is supplied from the factory in Manual exposure mode with the three dials assigned to the following primary function:

1. Front Dial – Shutter speeds
2. Side Dial – Aperture values
3. Rear Dial – ISO values

Top Touch Screen Operation

All settings and modes displayed in the main panel on Top Touch Screen can be selected and adjusted by touch. Tapping one of the settings or icons will change the display accordingly, see below for more details.

If using the camera in the cold with gloves, for instance, the same settings and modes can also be accessed using the following operation:

1. Front Key – Press for access to Camera Function mode. Press again to navigate to the next setting or mode, or scroll through the settings with the Front Dial instead.
2. Rear Dial or Side Dial – Scroll to make adjustments to the chosen setting or mode. Once selected, no additional confirmation is required.

If operating the camera from the rear, positioned at a high-level on a tripod for example, the main panel can be duplicated on the IQ Touch Screen and operated either by touch or using the IQ back's Rear Keys instead.

User Control Buttons

The User buttons are assigned specific functions from the factory, but can be re-assigned to another function.

1. Front User Button – Press and hold to operate the depth of field preview. The Aperture will close according to the value set on the main display and will remain closed as long as the button is pressed. The Aperture cannot be adjusted while this function is in operation.
2. Rear User Button – Press briefly to lock exposure settings (note when activated, the viewfinder displays the Shutter Speed and Aperture value enclosed by brackets). Press briefly to deactivate the function.

Front and Rear Keys

The Front Key is assigned to access the Camera Function mode, primarily as an alternative to operating the camera without touch (see above).

The Rear Key accesses the Camera Menu system.

Shutter Release Button

Half press activates AF and metering systems. If navigating the menu, selecting functions, or if the camera is in Display Off (sleep) mode, a half press will return the XF to instant readiness.

NOTE:

A secondary shutter release control is available on the front lower-right side, if you want to shoot handheld in portrait orientation or when using the optional waist level finder.

Top Touch Screen Layout

Classic Layout (Default)

The XF OneTouch UI is setup by default to display the camera's current configuration using the Classic layout on the top screen. Apart from the Shutter Speed, Aperture value and ISO setting, the Classic layout also displays the Exposure mode, Exposure Compensation, Drive mode, Light Metering mode, Focus Area and Mirror Lock-up setting. Tapping on any item on the screen with your fingertip allows you to set the parameters for that function. Touching the Battery icon will display the camera's status, including the number of shots remaining on CF card. If there's no CF card in the back, the Battery icon is replaced with a flashing red Folder icon as a warning.



Classic Layout (Default)

Simple Layout

A Simple layout is offered as an option from the XF menu (or the IQ XF Camera menu). This layout may be preferred because it displays only the exposure settings (including exposure correction, if set) and battery power level (and camera status). However, touching the exposure scale will display the Drive mode, Metering mode, Focus Area and Mirror Lock-up icons momentarily and allow adjustment, if required.



Simple Layout

Waist Level Layout

Waist Level Layout is based on the Simple layout, but with an additional focus confirmation indicator, which is very convenient, when working with the XF Waist Level Finder. With this layout the focus confirmation indicator, known from the prism viewfinder, now appears on the XF top screen and guides you to finding the best focus



Waist level Focus indicator

Change Screen Layout

Press the Rear Key on the XF top screen and from the menu select UI Setup > Layout > Classic / Simple / Waist.

Note with the Simple and Waist layout you can use the same Auto On/Off feature for the Exposure modes and ISO as in the Classic layout, without having the screen cluttered with settings you rarely change.

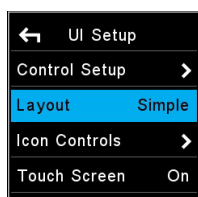

Simple Layout

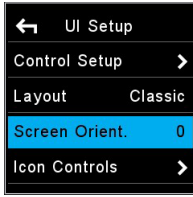

Screen Orientation normal

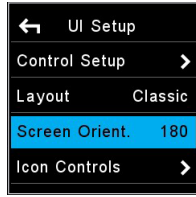

Screen Orientation at 180 degrees

Screen Orientation

It is possible to turn the screen orientation of the top touch screen 180 degrees. This is done by selecting UI Setup > Screen Orient. > 0 / 180 and causes the screen to be viewed upside-down. Please note that this does not change the assignments of the dials or buttons. The only change is that the dials are reversed within the menu, making it easier to navigate the menu system. The functionality is intended to be used when the XF is mounted in a stand pointing downwards, for example in a copy-stand.

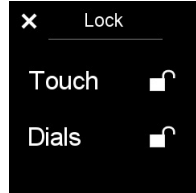

Lock Screen

Sliding in the Lock Functions on the top screen

Swiping your finger from left to right on the XF top screen brings in the Lock Screen. In the lock screen you can toggle touch and Dials on and off by touching the lock icons. Once the Touch is locked none of the touch functions on the screen will respond, except the sliding function that can bring in the tool to unlock again, or give access to display some of the other Tools, but no edits or changes can be made while it is locked.



Icon Controls pop-up window

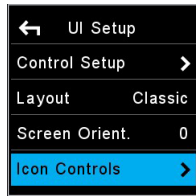

Icon Controls

Customize the Icon Controls

At the bottom of the top touch screen, there is a row of four shortcut icons that makes it possible for you to quickly access certain settings or tools. These icons can be configured to access the tools that you prefer. Press the top rear key and select UI Setup > Icon Controls. Next, select a tool that you wish to enable as a shortcut icon, and turn the Side Dial to choose one of the four positions. Note that you can also change a shortcut icon simply by pressing on one of them on the top touch screen for a few seconds and then choosing the new desired setting or tool from the pop-up window.



Shutter Time options

Auto Functions on Shutter Speed, Aperture and ISO

Tapping on Shutter Speed, Aperture or ISO changes the display and lets you turn on the Auto option for each and set upper and lower limits. For example, you can set ISO to Auto and select a range of ISO settings for the camera to operate within.

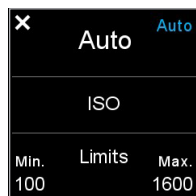

Auto ISO options

Aperture priority is selected by tapping the Shutter Speed setting on the touch screen, and then selecting Auto. If both Aperture and Shutter Speed are set to Auto, the camera will operate in Full Auto (Program) exposure mode.

If Shutter Speed, Aperture or ISO is set to Auto, they will be highlighted in blue on the screen as a reminder. Setting either Shutter Speed or Aperture to Auto mode will also alter the Exposure mode icon in the main display to reflect this change.

If Auto ISO is set together with Auto Shutter Speed or Auto Apertuer or both, then the ISO is only changed if a properly exosed image cannot be obtained using Shutter Time range or aperture range.

If ISO is set to Auto, the XF Camera will always try to make an exposure with lowest possible ISO selection.

XF Tools on the Top Touch Screen

The XF Camera has a number of highly useful tools that can be a great aid when working with different types of photography. They are all accessed from the Top Touch Screen and are divided into two major types; photographic tools and analysis tools.

The Photographic Tools are:

- HDR Tool
- Timelapse Tool
- Focus Stack Tool
- Hyperfocal Tool
- Focus Trim Tool
- Profoto Remote Tool
- Seismograph Monitor
- BullsEye Level Tool

The Analysis Tools are:

- Flash Analysis Tool
- Vibration Analysis Tool
- Histogram

Swiping to get to the XF Tools

Swiping your finger continuously over the XF top touch screen will reveal the tools one by one in an endless loop along with the screen Lock function. Note that you can also access a Tool by going to the XF menu, selecting Tools and then choose the desired one. This might be a more practical way to navigate the top touch screen if you are wearing gloves.

Switching the XF Tools on and off

Which tools are available on the top screen can be changed in the XF menu system under UI Setup > Tools Enabled. Here they can be switched on and off. If a tool is switched off it will not appear in the loop on the XF top screen.

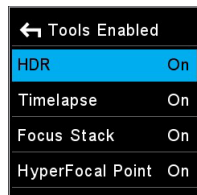

Tools Enabled on Top Screen

Advanced Tool Options

Note that some of the tools have additional settings that control advanced features. If any of these are available in chosen the tool, an icon will appear just below the close tool icon in the upper left corner. Just tap on the tool option icon in order to access the advanced settings.

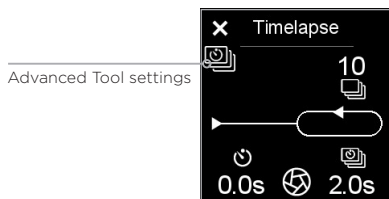

Advanced Tool settings

HDR Tool

From the main screen, swiping your finger from right to left on the XF top screen reveals the HDR tool. This tool is essentially the same as the bracketing function on the camera, but with a few convenient extra features attached. HDR Tool will use whatever settings you have setup on your camera, and capture a series of images where it changes the aperture in between.

The HDR sequence is setup using the Rear dial and the Side dial to adjust number of captures and EV deviation between captures.

The Front dial can be used to toggle the vibration delay on and off.

Once the HDR sequence is setup, you press the Rear user button to start capturing the images.

One advantage of using this feature over the standard bracketing mode is that the camera will store Sequence metadata into the files, and thus Capture One Pro can parse these files as part of a sequence, and you can do smart selections or smart albums of all related files.

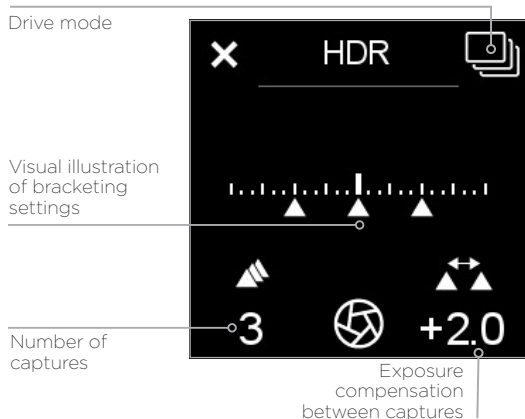

Timelapse Tool



At second position when swiping to the left is the Timelapse tool.

As with the other sequence tools, metadata is stored in the files to indicate that the files are part of a timelapse sequence, and also which position they are in the timelapse.

Set the number of images you want in the Timelapse using the Front Dial, and the seconds between using the Side Dial.

If you want a delay before the timelapse starts, this is set using the Rear Dial. Image capture is started from the rear button, and images are captured with the current camera settings.

Values that are indicated as red, is out of range - for instance if there is not enough storage for all the images, or the time between each capture too fast for this specific camera-digital back combination or digital back file format setting.

As an advanced feature, it is possible to temporarily suppress the black frame calibration during a timelapse. This is useful when doing long exposures, because the additional time taken by the black frame calibration could end up exceeding the desired time between the captures. Beside the **Normal** operation mode there are 3 other black frame options that can be set:

- **Always.** A black frame reference is generated for every capture.
- **Suppress.** The black frame reference will be suppressed.
- **1st.** The black frame reference is done on first capture, which ensures that reference shot is as close as possible to the capture Temperature and timing of the images in the Time Lapse. With the black reference option set to "1st", the XF Camera will only do a black reference if it is really needed because of significant temperature drift during the time lapse.

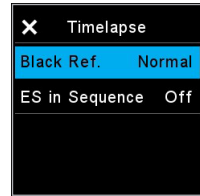

Timelapse advanced options

You choose the black reference option by tapping on the advanced tool option icon and selecting the option required with the Side Dial. Once it is active, the suppression is indicated with a red cross over a moon. Please note that the image quality may be degraded as a consequence to selecting "Suppress", but since timelapse sequences are typically used to make videos in a lower resolution, it could often be an acceptable compromise.

Note that the setting will revert back to the Normal black frame calibration between each capture when the camera is turned off. You can also enable the Electronic Shutter for capturing with the ES in Sequence option. This requires that your IQ Digital Back support the ES feature.

You can also enable the Electronic Shutter for capturing with the ES in Sequence option. This requires that your IQ Digital Back support the ES feature.

Focus Stack Tool

Focus stacking is especially useful to create macro images with a great depth of field that would not be possible by just stopping down the lens, because that would cause diffraction. There are many ways to compile a Focus stack once the images are captured, one of the best software packages for Focus stacking is Helicon Focus which you can read about at www.heliconsoft.com.

Using the Focus Stack Tool

The Focus Stack Tool is designed to automate the sequence capture involved in making a focus stack of images. The tool will automatically suggest the number of images needed based on the optical quality of the lens, the aperture setting and the area and pixel size of the digital back.

To setup a capture sequence for focus stacking your lens need to be set to Auto Focus. When using this tool the front and Side Dial will adjust the focus of the lens in MCUs (Motor Control Units). Front dial is used for small increments (x 1 MCU), and Side Dial is used for larger increments (x 10 MCU).

1. Setup the near-focus distance using the front and Side Dial. Once you have set the near-focus, store this value by pressing the Top rear key.
2. Then setup the far-focus with the front and Side Dial. Once you have the far-focus adjusted, press the Top front key to store this value.
3. The XF Camera will now automatically calculate the optimal number of images, if your lens support this feature. In this case, the number will displayed in a blue color.
4. If the number of captures is displayed in white, you will need to adjust the amount manually. This is done with the Rear dial.
5. When you are ready to capture, press the Rear User button to start the sequence.



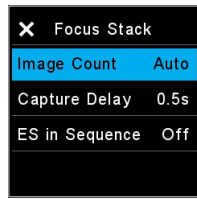

Advanced Focus Stack settings

Note that it is possible to introduce a small delay between each capture when doing focus stacking. This might be necessary when shooting with a flash system that needs a few seconds to recharge. You choose the delay by tapping on the advanced tool option icon and selecting the desired time from Capture Delay, specified in seconds.

The advanced options also let you change whether the tool should calculate the optimal number of images automatically with the Image Count option. Setting this to Manual will disable the auto-calculate feature.

Re-using Focus Stack settings

The Focus Stack Tool will remember the settings used even if the XF Camera have been turned off. The settings will be saved until the lens is changed.

Supported lenses for Automatic Focus Stack Calculator

Currently (as of XF Feature Update #4 SR2) the Automatic Focus Stack Calculator are supported on the following Schneider Kreuznach lenses (both Blue Ring and non-Blue Ring):

- 35mm LS f/3.5
- 45mm LS f/3.5
- 55mm LS f/2.8
- 80mm LS f/2.8
- 110mm LS f/2.8 Macro
- 120mm LS f/4.0 Macro
- 150mm LS f/2.8
- 150mm LS f/3.5
- 240mm LS f/4.5 IF
- Additionally, the Phase One 120mm AF Macro f/4.0 is also supported.

Focus Stack Tool and Capture One

Once you have created the images to be used in the focus stack, you can bring them into Capture One (or if you already shot the images tethered, which is also possible). In Capture One 9.1 and later, you will be able to easily select all images by the Sequence ID metatag created by the XF Camera. Now you can create a smart folder or a selection of these images. When you are done editing, you can output them and stack them using your preferred focus stacking software.



HyperFocal Tool

Hyperfocal Tool

Next to the Focus Stack Tool when swiping left on the XF Top Screen, is the Hyperfocal tool. Hyperfocal tool is designed to set your lens hyperfocal position. The hyperfocal position is the point or marker many photographers set on their lens to easily adjust focus to the hyperfocal distance when shooting landscapes. The Hyperfocal Tool is described in more detail later in this manual. Please read ahead to get more information on this tool.

Focus Trim Tool

This tool will guide you through the process of obtaining the optimal Focus Trim, making sure that the focus system will achieve the best possible accuracy.

Your XF Camera and lenses are manufactured to the highest precision standards, however even slight differences within the tolerances of the autofocus system can lead to the focus being a touch off. The Focus Trim Tool removes this issue by shifting the plane of focus slightly forwards or backwards until a perfect compensation is achieved and stored within the focusing system.

The Focus Trim Tool is disabled by default from the top touch screen because it is not supposed to be used regularly. This means that you need to activate it in the XF menu system under Tools or alternatively enable it under UI Setup > Tools Enabled if you want to be able to use the swipe action to activate it.

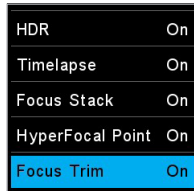

Enabling Focus Trim Tool

Use the supplied Phase One Focus Trim Target or download it from www.phaseone.com and print it. Mount the XF Camera on a tripod and make sure that it is perpendicular to the focus target.

Next, make sure that the XF Camera is setup correctly by using the largest aperture of the lens, for example f/2.8, setting the Drive Mode to Vibration Delay, metering to Spot, and AF Mode to Average Focus.

Once you are ready, select the Focus Trim Tool as explained above. Then press Start Tool. The XF Camera will now automatically check whether all the conditions for a reliable focus trim process are met. It will for example check whether the autofocus target has a proper distance, that the amount of light is sufficient and whether the camera can do an auto focus on the target.

If all conditions are met, you are prompted to adjust the focus. This can either be done in Live View, by pressing the Live view button, or by capturing images with the rear user button. In Live View zoom to 100% on the screen. Then move the Side Dial and Front Dial until you have achieved the maximum sharpness. Start with the Side Dial, as it will adjust focus in larger 10x increments, then use the Front Dial for fine-tuning in the smaller 1x increments.

Once done, press Start Trim and the Focus Trim Tool will measure whether the camera can detect focus reliably. If this automatic step is a success, the next step is to save the acquired Focus Trim value by either pressing the Save icon on the touch screen or by pressing the Top Rear Key.

The Focus Trim Tool is described in full detail in the Honeybee Autofocus System section later in this manual.

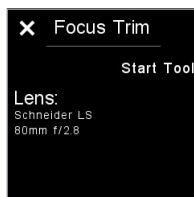

Start Focus Trim procedure



Adjust focus manually



Start automatic trim



Save Focus Trim value

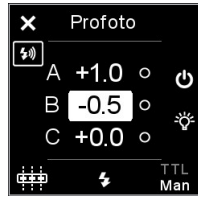

Profoto Remote Tool

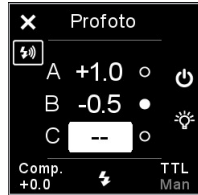

Turning a Flash Group off

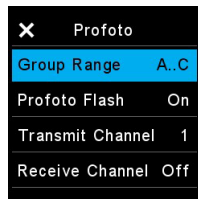

Advanced Settings menu for Profoto Tool

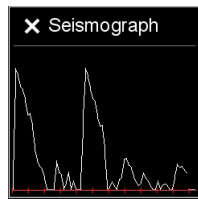

Seismograph monitor

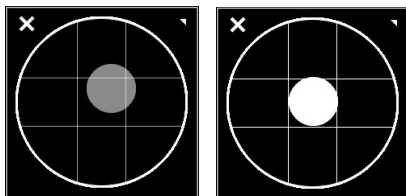

BullsEye levelling tool

Profoto Remote Tool

The XF Camera System can wirelessly control any Profoto Air-enabled flash system through the Profoto Remote Tool. You can swipe with your finger to get to the tool, but you also have the option of assigning it to one of the four shortcut icons in order to access it quickly. Please note that you have to activate the wireless feature by accessing the camera menu and selecting Capture Setup > Profoto > Profoto Flash > On.

You select and move through the different Flash Groups A, B and C with the Front Dial, and then change the selected energy level, indicated in stop increments, with the Side Dial. Note that any changes you make to the energy levels with the Profoto Remote Tool are done as incremental values that add or subtract from the current energy levels on the flash generator.

The top front key will turn the selected Flash Group on and off, while the top rear key will turn the Model Light on and off for the selected group. The rear button on the XF Camera is used to test fire the flash system.

You can change between shooting in Manual mode or TTL mode by turning the Front Dial until you reach the option at the right bottom corner of the Profoto Remote Tool. Then turn the Side Dial to switch.

Note that when Manual mode is selected, the Rear Dial will change the energy level for all Flash Groups at the same time regardless of which group is selected. If TTL mode is selected, the Rear Dial will instead control the flash compensation value. The Profoto Remote Tool is described in more detail in the Flash Photography section later in this manual.

Seismograph Monitor

The XF Camera System is built with precision as a focus. With this in mind, there is an available Seismograph on the XF Camera System OneTouch UI. Like with the BullsEye Level Tool you can bring in this monitor by swiping sideways on the XF top screen. The Seismograph is available to monitor all vibrations which may adversely effect the sharpness of your captured image. The seismograph sensor is also used in connection with vibration delay explained under XF Camera System Capture Modes later in this manual.

BullsEye Level Tool

The XF Camera System includes a BullsEye levelling tool. To activate it you can either swipe it in, by swiping sideways on the XF top screen, or press the Rear Key of the XF OneTouch UI and from the menu select: Tools > BullsEye (select using the Rear Dial and the rear key). The BullsEye tool is calibrated to match the levelling tool found in the digital back's image-tools-list in Play mode. When this tool is accessed for the first time, it is necessary place the XF Camera System on a flat surface (+/- 20°) to facilitate calibration. Calibration is then retained until manual calibration is applied through the 'long press' tool accessed in the upper right corner. this will invoke the manual calibration.

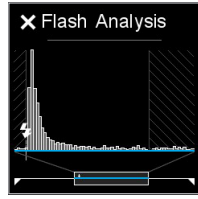

Flash Analysis Tool

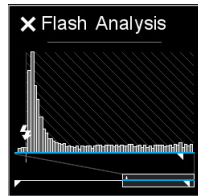

Flash Analysis Tool with flash curtain set to Rear

Flash Analysis Tool

The Flash Analysis Tool can be used by the photographer to verify that the flash light has been fired exactly where it should be during the exposure. The XF Camera System measures the incoming light during the exposure and can display the light energy from the captured image. Note that the flash pulse is shown as a magnified part of the entire exposure. The highlighted selection on the bottom timeline shows where the flash was fired, depending on whether you have set the flash curtain as front or rear. This is done by accessing the camera menu and selecting Capture Setup > Flash Curtain > Front/Rear.

In case the flash curtain is set to rear, the Flash Analysis Tool can be very useful to ensure that all of the light from the flash reaches the sensor before the shutter starts to close. If this is not the case, you can move the flash trigger signal by using the Rear Curtain Trim setting. A negative value moves it earlier, while a positive value moves it later. To find this setting, access the camera menu and select Capture Setup > Rear Curtain Trim.

The Flash Analysis Tool is described in more detail in the Flash Photography section later in this manual.

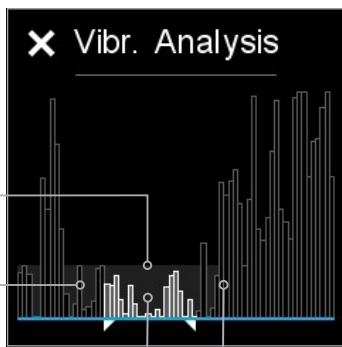

Threshold for acceptable vibration amount

Vibration amount before capture

Vibration amount during capture

Vibration amount after capture

Vibration Analysis Tool

The Vibration Analysis Tool is useful when you want to check whether the capture might have been affected from vibration during the exposure. The information is based on the built-in sensors in the XF Camera that detect rotation and vibration and is available for the latest captured image.

The peaks in the Vibration Analysis Tool represent the amount of vibration during time. The white vibration peaks - encapsulated within the two white markers - represent the exposure time, while the grey colored peaks denote the time just before and after the capture, respectively.

The grey zone at the bottom of the graph roughly represent a safe zone where the amount of vibration shouldn't affect your capture by blurring the image.

It should be noted that it can be difficult to judge whether a capture has been blurred from vibration based on the analysis graph alone. For example, a series of vibration peaks could have a larger blurring effect on the image than a single high peak. When in doubt, you should always check the captured image to see whether it is sharp.

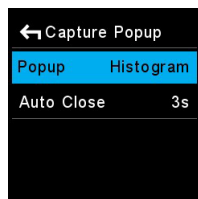

Cature Popup options

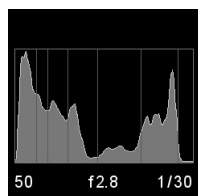

Histogram

Capture Analysis Popup

The XF Camera can automatically show you one of the Analysis Tools on the top touch screen after each capture. You can choose to either get the Histogram, the Vibration Analysis Tool or the Flash Analysis Tool displayed. It is also possible to disable the Capture Popup all together.

You setup the Capture Popup by pressing the Rear Key and selecting UI Setup > Capture Popup. Then select Popup and turn the Side Dial to choose between the four options.

Note that you also have the option to choose how long the Capture Popup should be displayed after each capture with the Auto Close option. If you set the option to No, the chosen analysis tool will be displayed until you touch the top screen or a button or dial.

IQ4 Navigation

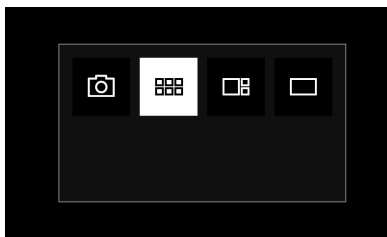

Changing mode on the touch screen

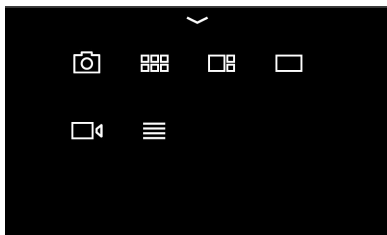

Swipe up for Shortcuts Menu

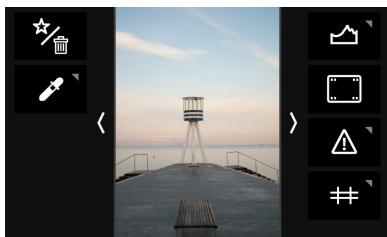

Swipe in for Actions (left) and Tools (right)

Touch Screen Operation

The 3.2-inch touch screen on the IQ4 let you use touch gestures like swipe to browse through images quickly, pinch to zoom in to an image as well as activating tools and adjusting settings.

The operation of IQ4 is divided into four major modes: **Camera Controls**, **Browser**, **Tools Viewer** and **Viewer**. You cycle through them by pressing the top-left button on the IQ4 and tapping the button until the desired mode is chosen in the Mode Bar. If you tap just once on the top-left key, it goes back to the last used mode. This way you can quickly switch between **Camera Controls** and **Tools Viewer**, for instance, even though they are not next to each other.

You can also select a mode from the **Shortcuts Menu** that is accessed by swiping up from the bottom of the touch screen.

The IQ4 will start up in **Camera Controls** as default.

Accessing Tools, Settings and Status

While in any of these modes, you can always access the **Shortcuts Menu** and the **Status Menu**. There is also a number of context sensitive **Actions** and **Tools** that you can control while in the **Camera Controls**, **Browser**, **Viewer**, **Tools Viewer** or **Live View** mode.

See next page for a visual guide to the swipe feature.

There are the four different edge gestures where you swipe from the edge on the screen and inwards.

- Swipe from **top edge** and downwards activates the **Status Menu**
- Swipe from **bottom edge** and upwards activates the **Shortcuts Menu**
- Swipe from **left edge** and inwards activates the **Actions** (like Delete, Rating, etc.)
- Swipe from **right edge** and inwards activates the **Tools** (Histogram, Clip Warning, Metadata, etc.)



You close the **Shortcuts Menu**, **Status Menu**, **Actions**, and **Tools** again by swiping in the opposite direction towards the edges.

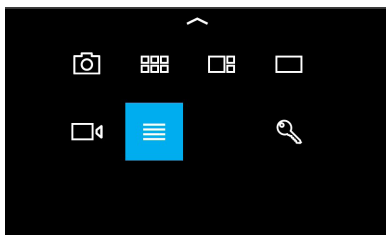

Shortcuts Menu with IQ4 Main Menu selected

Using the Shortcuts Menu

The **Shortcuts Menu** (swipe up from bottom) have a number of shortcuts to select modes or the IQ4 Menu. It is similar to the Contextual menu on the older IQ3.

The features and settings that you can select from the **Shortcuts Menu** are:

- Camera Controls
- Browser
- Tools Viewer
- Viewer
- Live View
- IQ4 Main Menu
- Lock (if enabled)

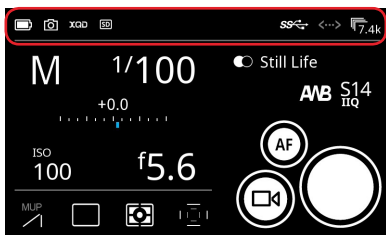

Status Bar

Using the Status Bar

The Status Bar area at the top of the screen will show you key information about battery, memory cards and connections.

The icons for USB-C, Ethernet and WiFi are only displayed in the Status Bar if there is currently a connection (cables for USB-C and Ethernet, wireless for WiFi). A gray icon indicates that there is a connection, but no computer host (Capture One) is currently present. A white icon indicates that there is a host.

If you swipe down from the top of the screen, the Status Menu will reveal more information (see next page).

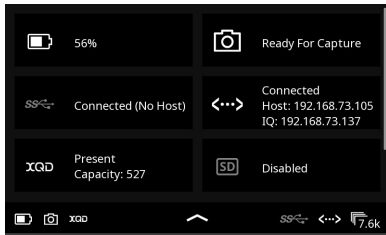

Status Menu

Status Menu

If an icon is greyed out instead of being white it means that it (like the SD card) is not currently present or active.

If you tap on one of the icons in the Status Menu, it will take you to the relevant setting in the IQ4 Menu. The following is a list of the 8 different points of information in the Status Menu and where they will take you in the IQ4 Menu System, if you tap on them:

- Battery Status -> Power Management
- Capture Readiness -> About
- USB-C Connection > Storage Setup
- Ethernet Connection > Network Settings
- XQD card presence > Storage Setup
- SD card presence > Storage Setup
- WiFi Connection > Network Settings
- Sensor Temperature -> Temperature

Swipe up from the bottom of the screen to close the Status Menu.

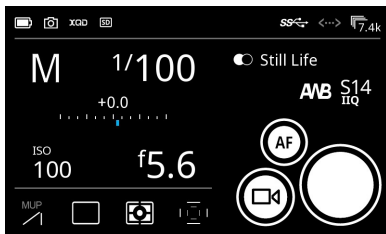

Camera Controls

Camera Controls

The default start screen is the **Camera Controls** where you can adjust exposure settings, change certain XF settings and capture the image. Please see the Camera Controls chapter on how to use it.

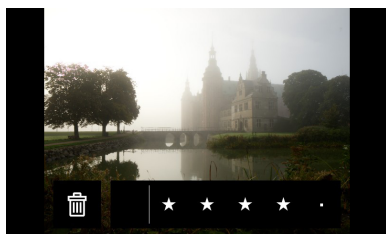

Viewer

Viewing Images

When you want to review the captured images, select either **Viewer** or **Browser** by pressing the top-left button on the IQ4 until it is highlighted or by swiping up from the bottom of the screen and select the desired mode.

Once in **Viewer**, you can browse through the captured images in full screen mode by swiping on the touch screen with one finger in either direction. You can also use pinch gestures to zoom in and out.

Please see the next chapter for all the information about viewing, deleting and rating images as well as enabling workflow features like Highlight and Clip Warning, adding a Grid overlay or showing file information.

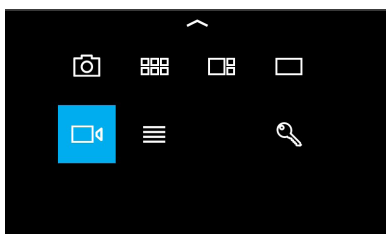

Live View icon

Live View

Live View is activated by swiping up from the bottom of the screen and select the movie icon. Please see the **Live View** chapter for full information about the available features and Tools in this mode.

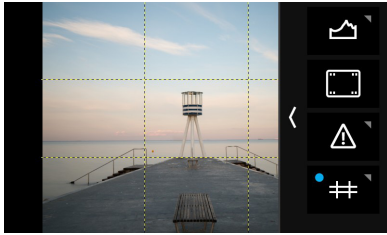

Tools settings

Changing settings in Tools

Some Tools have certain settings that can change their behavior or appearance. A small triangle in the upper right corner of the Tool icon indicate that there are settings available, and you access them by a long press on the icon.



Four Key Navigation

The IQ4 can also be operated by using the four keys on each side of the touch screen. While some touch gestures are faster and more intuitive, using the real keys can be necessary when wearing gloves or shooting in cold weather.

You open the IQ4 Menu system by a long-press on the bottom-left key.

In general, the bottom-left key is used to open a menu item or enable the selected menu item. The two keys to the right are used to navigate up and down. The top-left key is used to move a step back out of the currently selected menu item and will finally end in the Mode selected last, for example Camera Controls.

Key changes from the IQ1, IQ2 and IQ3:

- The IQ4 no longer have a Home Screen as the Camera Controls is now the default starting mode.
- The Status bar at the bottom of the screen has been replaced with the Status Bar at the top. It has been removed from the Browser, Viewer and Live View modes to make it possible to expand the image area on the touch screen.
- The full screen Contextual menu is replaced by Shortcuts Menu that you access by swiping up from the bottom edge. Some of the functionality has been moved to contextual edge Tools (left and right) for better integration and faster workflow.

Viewing Images



Viewing single Images

When you want to review the captured images, shift to **Viewer** by either pressing the top-left button on the IQ4 until it is highlighted or by swiping up from the bottom of the screen and select it.

Once in **Viewer**, you can browse through the captured images in full screen mode by swiping on the touch screen with one finger in either direction.

You can also use pinch gestures to zoom; zoom in to the image when pinching outward and zoom back out when pinching inward. Double-tap on the image is another way to zoom in and out of the image, going from fit screen to 100%, and back again.

While zoomed in on an image, you can pan around it by pressing a finger on the image and moving it.

You can swipe in from either the left or right of the touch screen to enable tools like a histogram or functionality like rating the current image.

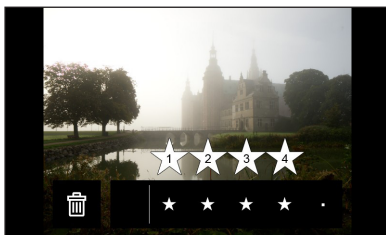

Delete a single image

With the image selected, swipe in from the left of the screen and press on the Rate/Delete icon to toggle the functionality on. A row under the image will now appear where you can delete the image by tapping on the Trash icon.

If you want to delete multiple images, please see later on how to do this from Browser.

Rating an image

With the image selected, swipe in from the left of the screen and press on the Rate/Delete icon to toggle the functionality on. A row under the image will now appear where you can rate the image by either tapping on the row or by swiping your finger along it.

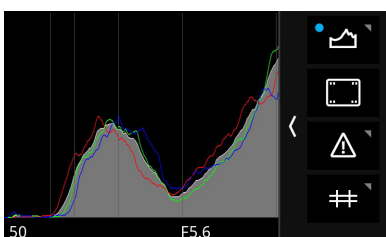

Displaying a Histogram

You can display a histogram in the Viewer to check for proper exposure. Enable it by swiping in from the right of the touch screen and tap on the histogram icon. Tap on it again to disable the histogram.

Note: The Viewer has an alternative mode similar to that on the IQ3 where certain tools are always displayed to the right of the image. Please see the Tools Viewer chapter for full information about the available Tools in this mode.

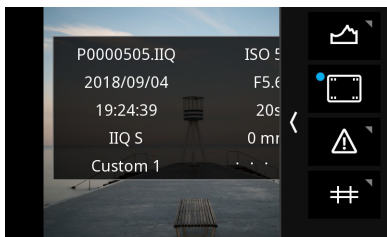
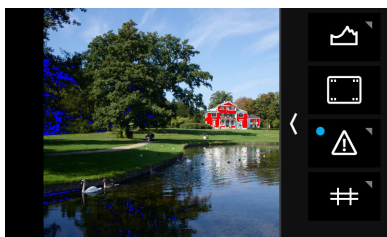

Image Info

You also have the option to display different kinds of metadata information like rating, file name, and Exif data. Swipe in from the right of the touch screen and tap on the second icon to enable it.



Exposure Masks

You can display different kind of masks on the images to ensure that exposure is correct. This is done by swiping in from the right of the touch screen and tapping on the icon with the exclamation mark. Tap on it again to remove the information.

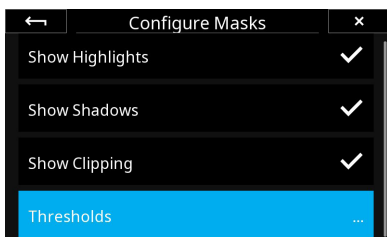

It is possible to toggle the different kind of masks on or off by long-pressing on the icon until the **Configure Masks** menu becomes available.

Then choose the **Show Highlights**, **Show Shadows** and **Show Clipping** as desired. Note that the Show Clipping option is based on the RAW data in the image file. This is a great feature as any clipping warning on an image will alert you that the highlight information is gone and cannot be recovered.

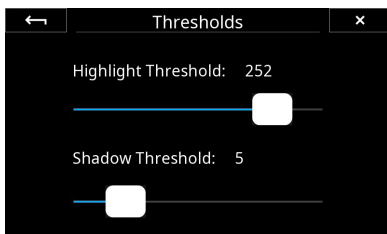

You can also adjust the threshold of Highlight (red color) and Shadow (blue color) warnings by selecting Thresholds...

Then move either the **Highlight Threshold** or the **Shadow Threshold** slider until they reach the desired level.

Close the menu by tapping on the arrow in the top-left corner.

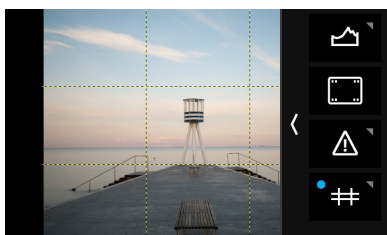

Displaying a Grid

You have the option to display different types of grid overlays in the Viewer as a composition aid.

You enable the grid by swiping in from the right of the touch screen and tap on the icon with the grid lines. Tap on it again to disable the grid.

You can change the grid type by long-pressing on the icon until the Grid Mode menu becomes available. Then choose either the Square, Golden Ratio, Center Cross, or 3x3 option and close the menu by tapping on the arrow in the top-left corner.

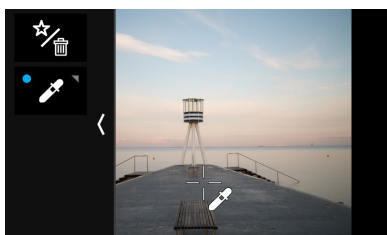

Setting a Custom White Balance

Swipe in from the left and tap on the **White Balance** Picker icon to activate the tool. Then drag the White Balance Picker icon with your fingertip to the point on the image that you want to reference as a neutral tone (a gray patch, or a light gray neutral area in the image). The tool will now automatically adjust the white balance based on the color in that spot.

Next, tap on the White Balance Picker icon on the screen and you will get the option to save the white balance adjustment as either **Custom 1**, **Custom 2** or **Custom 3**. The setting is automatically saved and all subsequent captures will use this white balance setting.

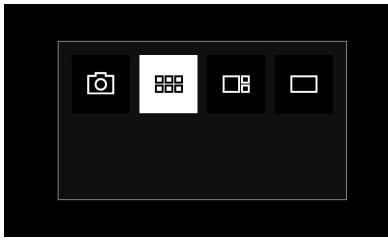

Viewing Images as thumbnails

If you want to view the captured images as thumbnails then either press the top-left button on the IQ4 until the **Browser** icon is highlighted or by swipe up from the bottom of the screen and select the **Browser** icon.

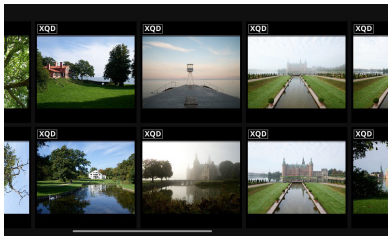

You can then browse through sets of thumbnail images by swiping on the touch screen with one finger in either direction. You can also press the bottom-right key on the IQ4 to select the next image or press the top-right key to select the prior image. The selected image is highlighted with a blue frame.

Tap on an image to select it and show it in full screen **Viewer** mode.

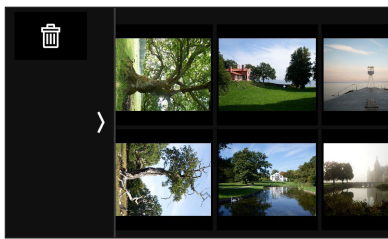

Deleting multiple images

When in Thumbnail browser mode, swipe in from the left of the screen and press on the Delete icon.

You can now choose to delete a single selected image, a range of selected images, or delete all images.

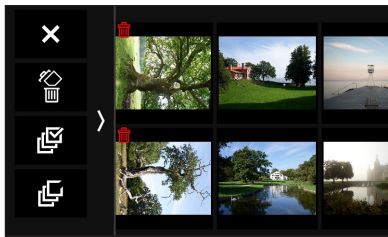

You select one or multiple images for deletion by tapping on them. A small trash icon will denote that they have been selected for deletion. Then swipe in from the left of the screen and tap on the Trash icon (the second icon) to delete them.

The delete swipe menu also gives you the option to select all images for deletion or to deselect all images. Finally, you can discard to delete process by tapping in the top X icon.

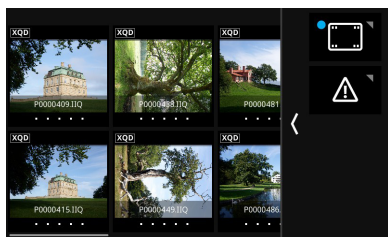

Browser Image Info

When viewing the images in **Browser**, you have the option to display different kinds of metadata information like rating, file name, and storage data.

You enable these by swiping in from the right of the touch screen and tapping on the metadata icon (top icon). Tap on it again to remove the information. You can toggle the different kinds of information on or off by long-pressing on the icon until the **Metadata Overlay** menu becomes available.

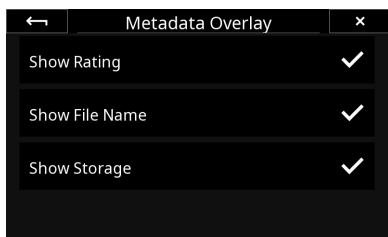

Then choose the **Show Rating**, **Show File Name**, and/or **Show Storage** as desired. Close the menu screen by tapping on the arrow in the top-left corner.

If you have enabled **Show Storage**, each thumbnail will have a row of small icons to indicate where the image is saved to, and whether a JPEG copy is saved in addition to the RAW files.

See next page for an explanation of the **Show Storage** icons.

XQD = The image is saved as RAW file on the XQD card
SD = The image is saved as RAW file on the SD card
Host = The image is saved as RAW file on the host computer (during tethering)
JPG = A JPEG copy of the RAW file is saved on the SD card

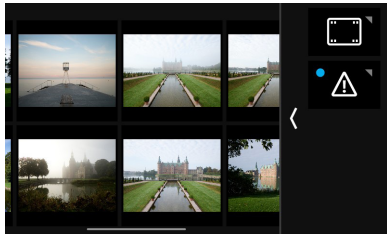

Browser Exposure Masks

You can display different kind of masks on the images to ensure that exposure is correct. This is done by swiping in from the right of the touch screen and tapping on the icon with the exclamation mark. Tap on it again to remove the information.

It is possible to toggle the different kind of masks on or off by long-pressing on the icon until the **Configure Masks** menu becomes available.

They work the same as with the exposure mask in the Viewer, so please see earlier in this chapter for formation on how to configure them.

Camera Controls

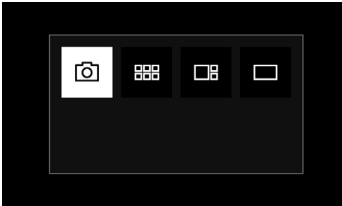

The start screen on the IQ4 is the Camera Controls that let you adjust exposure settings like shutter speed, aperture and ISO as well as other settings like white balance or applying a Style via the touch screen.

If you are in Live View mode or viewing images, you can get back to the Camera Controls by tapping on the top right button until it is selected.



The illustration on the left gives you a quick overview of the features. You just tap on an icon to change the settings.

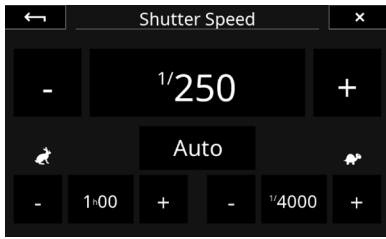

Setting the Exposure

Using the Camera Controls to change the exposure settings are straightforward - simply touch the shutter speed, aperture or ISO value icons to change them. Any changes will be reflected on the XF Camera Body.

Note that you can enable automatic exposure adjustment of the ISO value, Shutter Speed, or Aperture by tapping on the Auto icon. The automatic exposure adjustment is enabled if the selected Exposure Program is either Aperture Priority (Av), Shutter Priority (Tv), or Program (P).

Automatic exposure adjustment will show a blue dot on the Auto icon if it is enabled.

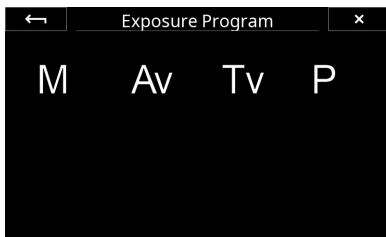

Selecting the Exposure Program

You can select the desired Exposure Program by tapping the settings icon. You can either choose Manual (M), Aperture Priority (Av), Shutter Priority (Tv), or Program (P). Any changes will be reflected on the XF Camera Body.

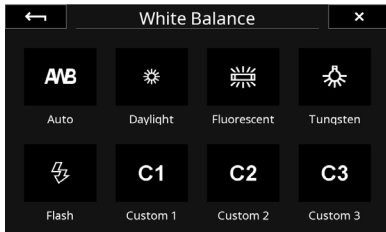

Setting the White Balance

You set the white balance by tapping the White Balance icon.

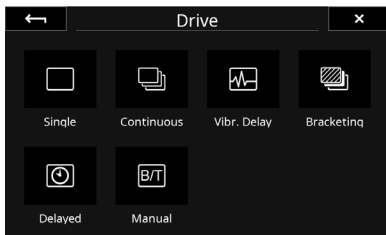

XF Camera settings

In addition to adjusting exposure and white balance, the Camera Controls also let you change some of the more common settings on the XF Camera Body.

These are accessed by the four icons on the lower left of the touch screen. You can adjust these XF Camera Body settings:

- Toggle the XF mirror Up/Down
- Drive Mode
- Metering Mode
- Autofocus Mode

Using Autofocus and capturing an image

If you have a XF Camera Body attached, you can autofocus on the target by pressing on the AF icon. Press and hold on AF until the XF Camera obtain focus by giving you a Focus Confirm beep. Note that the XF Camera needs to have the mirror down in order to use the Honeybee autofocus.

Once you are ready, just press the shutter button icon to capture the image.



Virtual Horizon Tool

The Virtual Horizon tool provides a quick and accurate visual aid to ensure that the camera is level in both horizontal and vertical planes and is particularly useful when the camera is mounted on a tripod. Swipe in from the right side of the touch screen and tap on the Virtual Horizon icon to activate it.

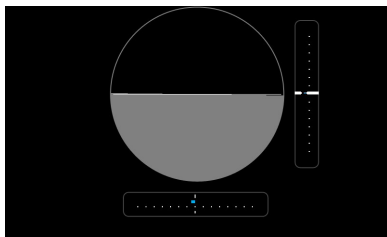

The Virtual Horizon tool will now be displayed full screen with a virtual horizon as well as a roll and a pitch Scale indicator bar.

Once you have ensured that the IQ4 is level, close the tool to return to the Camera Controls screen.

Tools Viewer



In addition to the Viewer, which is optimized to view the images as large as possible on the IQ4 touch screen, the IQ4 also have a Tools Viewer mode. This mode will provide you with the ability to view certain information — like a histogram or file metadata — side by side with the selected image. The Tools Viewer will also let you use certain Tools or information full screen, perfect for situations when you for example need to inspect a histogram in detail on the IQ4 screen.



Using the Tools Viewer

You activate the Tools Viewer by either pressing the top-left button on the IQ4 until the **Tools Viewer** icon is highlighted or by swiping up from the bottom of the screen and select the icon.

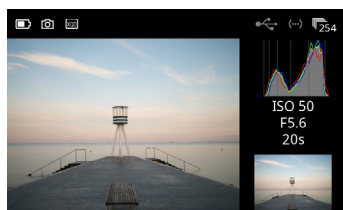

You can enlarge any of the information tools in column on the right side of the Tools Viewer by tapping on its thumbnail. Tap on the thumbnail again to close it and view the image instead.

There are three sections with tools on the right of the image.

Note that while in the Tools Viewer mode, you can still browse through the images by swiping with your finger either left or right on the image.

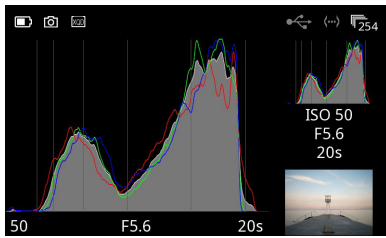

Histogram

The Histogram displays the brightness data per channel and allows the user to determine a level at which highlights start to clip. For improved accuracy, a custom white balance measurement should be performed first.

Press the Histogram thumbnail once to display it full screen. The EXIF information (ISO, f-stop and Shutter Speed) of the captured image is displayed below the Histogram. Press the screen again to return to the image view.

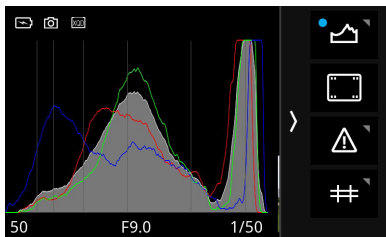

Swipe in from the right side and long press the Histogram icon to access a dialog box to alter the settings. You can choose between viewing the histogram with or without RGB information.

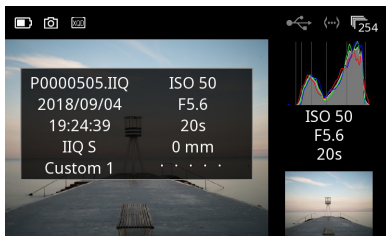

File Info

The File Info option displays the ISO, f-stop and Shutter Speed settings. Tap the File Info thumbnail to see more detailed information that includes the file name, date and time of capture, file format, white balance and the focal length of the lens.

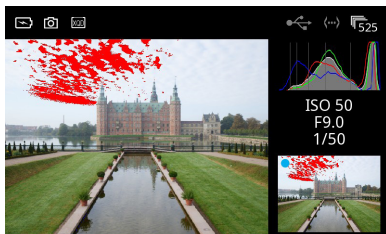

Exposure and Clip Warning

The Exposure and Clip Warning display different kind of masks on the images to let you check whether the exposure is correct. Press on the image thumbnail to display any burned out areas of an image with a red color overlay and lost shadow detail with a blue color. This tool also features a Clip warning option with a pink colored overlay based on the raw data for the most accurate visualization of the level at which highlights will clip. Tap on the thumbnail again to remove the information.

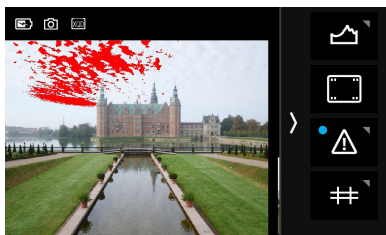

It is possible to toggle the different kind of masks on or off by long-pressing on the icon until the **Configure Masks** menu becomes available.

Then choose the **Show Highlights**, **Show Shadows** and **Show Clipping** as desired. Note that the Show Clipping option is based on the RAW data in the image file. This is a great feature as any clipping warning on an image will alert you that the highlight information is gone and cannot be recovered.

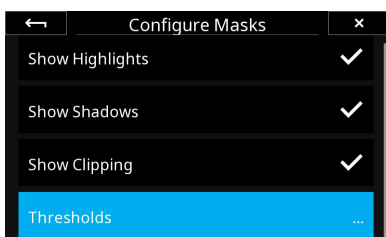

You can also adjust the threshold of Highlight (red color) and Shadow (blue color) warnings by selecting Thresholds...

Then move either the **Highlight Threshold** or the **Shadow Threshold** slider until they reach the desired level.

Close the menu by tapping on the arrow in the top-left corner.

Exposure Zone

This tool displays a visualization of the exposure range of the captured image based on the raw luminosity data and is useful in determining the absolute point at which highlights will clip. It can also be a valuable tool when deciding how shadows are to be rendered. Color tones are used to indicate the exposure range in either EV steps or Luminosity values.

To enable the **Exposure Zone** tool, swipe in from the right of the screen and long press on the Exposure warning icon (the exclamation sign). Then select **Mode** in the menu and change from **Masks** to **Zone System**. While in the menu, you can customize the appearance of the Exposure Zone tool by selecting **Configure Zone System** and choose whether you want to display a **Legend** and whether the exposure **Labels** should be denoted as **EV** steps, **Luminosity** values or turned off (**None**).

To toggle the visibility of the **Exposure Zone** tool on and off, tap at the bottom right thumbnail.

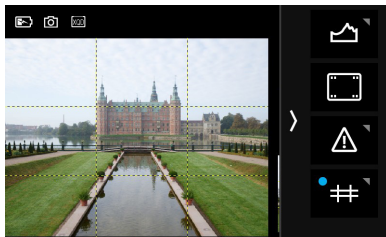

Displaying a Grid

You have the option to display different types of grid overlays as a composition aid.

You enable the grid by swiping in from the right of the touch screen and tap on the icon with the grid lines. Tap on it again to disable the grid.

You can change the grid type by long-pressing on the icon until the Grid Mode menu becomes available. Then choose either the Square, Golden Ratio, Center Cross, or 3x3 option and close the menu by tapping on the arrow in the top-left corner.

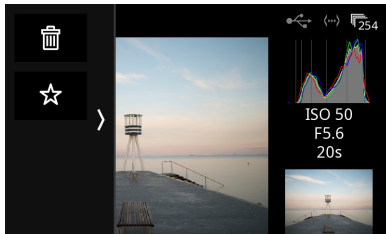

Additional tools

The Tools Viewer mode also have the same Actions as the regular Viewer mode, namely deleting and rating images, that you can access by swiping in from the left edge of the screen. Please see the Viewing Images chapter on how to use these.

Live View



The IQ4 can display a Live View feed on the touch screen. It is a very effective method for getting the focus right and checking for proper exposure prior to the capture.

The IQ4 also support tethered Live View using either USB-C, Ethernet or WiFi. In addition, you have the option to get a Live View feed output to an external monitor or screen via a HDMI connection (see the next chapter).

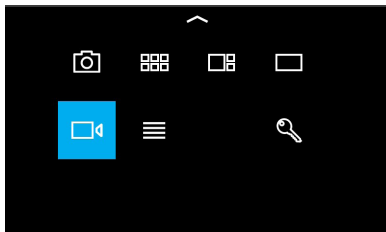

Activating Live View

Swipe up from the bottom of the IQ4 touch screen and press on the Live View icon. You can also press the Movie-camera icon in Camera Controls to initiate Live View. The XF Camera Body opens the shutter and a live view feed is displayed on the rear screen.

Zooming in Live View

You can use pinch gestures to zoom in to the Live View feed by pinching outward and zoom back out by pinching inward. Note how a number at the center top of the screen will display the zoom percentage for a few seconds. Double-tap to zoom to 100% and double-tap again to go to fit screen view. While zoomed in to the Live View feed, you can pan around by pressing a finger on the screen and move it.

You can zoom all the way in to 400% in Live View by either using the pinch-outward gesture or by triple-tapping on the screen. Triple-tap again to zoom back to fit screen view.

Live View Exposure Info

An Info bar at the bottom of the Live View feed will display the currently used ISO, Aperture value, Shutter time and exposure compensation.

- A Blue color signify that the value is automatically controlled by the camera system, like using Auto ISO. This is in line with the XF Camera.
- The Info bar will automatically disappear after a few seconds; if you need to check it again, just tap on the screen.
- The Info bar will also show you whether the IQ4 is currently in the Exposure Simulation or Auto Gain brightness modes by displaying either **Sim** or **Auto** (See next page).

Exposure Simulation

By default, the Live View feed on the IQ4's screen is using **Exposure Simulation** which means that the brightness of the Live View image will reflect the actual exposure settings (Shutter Speed, Aperture, and ISO values) and thus the final exposure of the captured RAW files.

The advantage of this feature is that you can adjust shutter speed, aperture and/or the ISO value until the desired exposure level is achieved based on the Live View feed. It is highly recommended to use Exposure Simulation in combination with the live RGB Histogram, RAW Histogram and Clip Warning features (see later in this chapter).

Exposure Simulation and Long Exposures

With the Exposure Simulation feature, the chosen shutter speed will reflect the frame rate of the Live View feed. This might not be optimal when using long exposures as the resulting low frame rate would introduce an interactive lag on the Live View feed. For this reason, the IQ4 will try to maintain practical frame rates on long exposures while adding a screen brightness compensation. This means that what you see is still what you get, exposure wise.



Using Auto Gain for Automatic Brightness

The Auto Gain feature will optimize the Live View image to show a bright and even exposure of the subject regardless of what exposure settings you have set. This is desirable when you need to check critical focus or the composition in dim light, for example when you are working with the modeling light of a flash system or out shooting at dawn. This is similar to how the Live View image was displayed on the IQ3.

The Auto Gain feature works as a toggle, making it easy to switch back and forth between Exposure Simulation and Auto Gain on the set. It is activated by swiping in from the left and tapping on **Auto**. The IQ4 will now analyze the image and adjust the brightness automatically. Note how the Info bar at the bottom will now display **Auto**. Swipe in from the left and tap on **Auto** to turn Auto Gain off again if needed.

Auto Gain is also referred to as ViewFinder Mode in the IQ4 menu system.

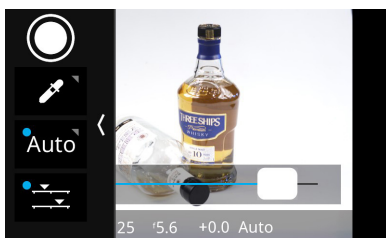

Adjusting the Auto Gain brightness

If the calculated brightness on the screen is too bright or dim, you can finetune it manually. Swipe in from the left and tap on adjustments icon at the bottom. Then tap on the slider and move it to readjust the brightness.

Swipe in and tap on the adjustments icon to dismiss the slider and accept the change.

Using Auto Gain with open or shooting Aperture

When using the Auto Gain feature in Live View, you can choose whether the lens aperture should be fully open or closed down to the shooting aperture. Using the aperture closed down to the shooting value will let you evaluate the real depth of field and sharpness throughout the image. Using the aperture fully open instead can make it easier to adjust the point of focus accurately. It will also let more light in, giving you a Live View feed with lower noise in very dim lighting.

You set the aperture behavior by swiping in from the left and long pressing on the **Auto** icon. Then select **LiveView Open Aperture** in the menu and set the function to **Enabled** (fully opened aperture) or **Disabled** (shooting aperture).

You should be able to hear the aperture open or close on the lens as you change the option, providing that your shooting aperture is not fully open.

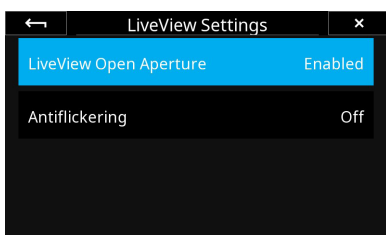



Enable Antiflickering

When using Live View, some light sources can cause flickering at either 50Hz or 60Hz. Enabling **Antiflickering** can mitigate this. You set it by swiping in from the left and long pressing on the **Auto** icon. Then select **Antiflickering** in the menu and choose either **50Hz** or **60Hz**.

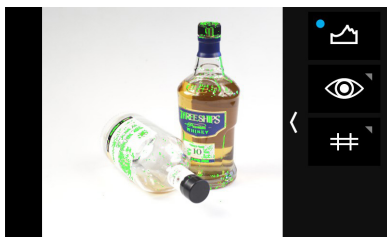

Live RGB and RAW Histograms

You can enable both a live RGB Histogram and a live RAW Histogram in Live View to help evaluate the exposure based on the current settings. The histograms will reflect the results of the captured image and are excellent tools to ensure that you get a proper exposure and doesn't clip either the shadows or the highlights.

You enable the live RGB and RAW histograms by swiping in from the right side of the touch screen while in Live View and toggle the feature on by tapping on **Histogram** icon.

Once the live RGB Histogram and live RAW Histogram is active, you can adjust shutter speed, aperture and/or the ISO value until the desired exposure level is achieved. This requires that you are using the **Exposure Simulation** mode.



Live RAW Clip Warning

The live RAW Clipping warning in Live View indicates the amount of raw data that are being clipped for each for the color channels (Red, Green and Blue).

Once a blue, green or red pixel is clipped, the bar will start to light up for the corresponding color channel. A full bar indicates that several pixels in the image are clipped in that color channel while a single bar indicates that only one or few pixels are clipped. This feedback will let you decide to what degree you might accept some partial clipping since Capture One can recover details in the highlights as long as not all three color channels are clipped.

You enable Clip Warning by swiping in from the right side of the touch screen while in Live View and toggle the feature on by tapping on **Histogram** icon.

Once the Clip Warning Tool is enabled, adjust shutter speed, aperture and/or the ISO value until the highlights are no longer clipped. This requires that you are using the **Exposure Simulation** mode.

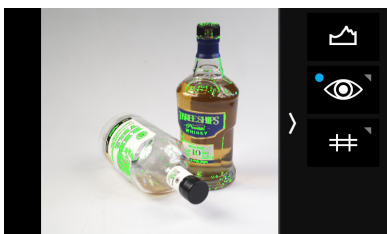

Focus Peaking

The Focus Peaking feature is a great aid to get the focus right as it will highlight the areas in the Live View feed that has high contrast and are thus likely to be in focus. It will update continuously as you adjust focus manually and is especially useful when you have zoomed into the image.

You enable **Focus Peaking** by swiping in from the right side of the touch screen while in Live View and toggle the feature on by tapping on **Focus Peaking** icon (it looks like an eye).

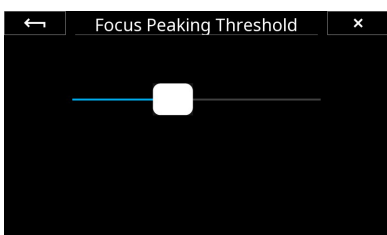

You can change the **Focus Peaking Threshold** by long-pressing on the icon. Then adjust the threshold by sliding the finger on the bar.

Note that the feature looks for high contrast areas, so smooth zones like skin tones or a clear sky might not be highlighted, even if that part of the image is within the depth of focus.

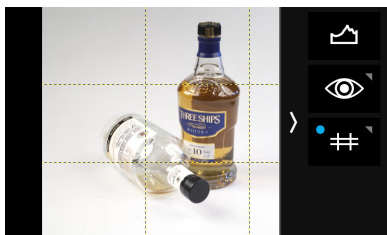

Displaying a Grid

You have the option to display different types of grid overlays in Live View as a composition aid.

You enable the grid by swiping in from the right side of the touch screen and tap on the icon with the grid lines. Tap on it again to disable the grid.

You can change the grid type by long-pressing on the icon until the **Grid Mode** menu becomes available. Then choose either the Square, Golden Ratio, Center Cross, or 3x3 option and close the menu by tapping on the arrow in the top-left corner.

Manual Focus in Live View

Auto focus is not available during Live View. Select Manual Focus (MF) from the Lens Selector Ring and focus on the subject using the Live View image. To make a quick zoom to 100%, double-tap on the area of interest.

Note that Focus Peaking can be a great aid to great the focus right, and that it will also work when you are zoomed into the image.

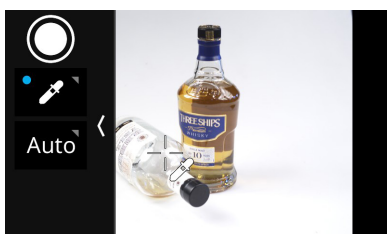

Image Capture in Live View

You can capture an image while in Live View by pressing the shutter release button on the XF Camera Body (or via a connected cable release), but you also have the option to capture directly from the Live View screen.

To do this, swipe in from the left of the screen and tap on the **Capture** button to take the shot.

If you want to prevent any vibration in the images, it is recommended to select the Low Vibration mode or enable the Single (or Continuous) Drive modes on the XF Camera Body and use a cable release.



Setting a Custom White Balance

Swipe in from the left and tap on the **White Balance Picker** icon to activate the tool. Then drag the White Balance Picker icon with your fingertip to the point on the image that you want to reference as a neutral tone (a gray patch, or a light gray neutral area in the image). The tool will now automatically adjust the white balance based on the color in that spot.

Next, tap on the White Balance Picker icon on the screen and you will get the option to save the white balance adjustment as either **Custom 1**, **Custom 2** or **Custom 3**. The setting is automatically saved and all subsequent captures will use this white balance setting.

Note that you can access additional White Balance settings by long-pressing on the White Balance icon. Please read the Custom White Balance chapter for more information.

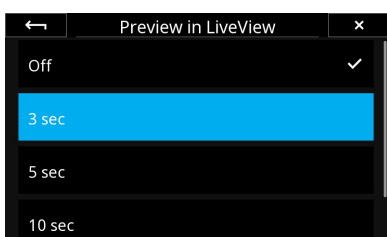

Preview Time

You can select how long a preview of the captured image should be displayed on the screen before returning to the Live View feed. This is done by going to the menu and selecting **IQ Settings > Preview > Preview in LiveView**. You can set it from 3 to 10 seconds. Note that it is also an option to turn Preview off, if you prefer an uninterrupted Live View feed.

Live View over HDMI

The Live View feed as well as many of the Live View features mention in the prior chapter can be mirrored to a HDMI target device like an external monitor in the Full HD resolution of 1920 x 1080 pixels. This can be especially handy if you are working outdoor in bright sunshine where an electronic viewfinder can be a great aid. Just ensure that the monitor accept a HDMI cable as the input signal.



Connecting HDMI

The IQ4 uses a HDMI Type C port (also known as HDMI Mini) for HDMI connections. Plug the supplied HDMI C to A angled adapter into the HDMI C port, then attach a normal HDMI A cable to the adapter and the desired monitor or recording device.

NOTE: The HDMI adapter cable will adapt to any standard HDMI A male to male extension cable. If you want to replace the adapter with another standard HDMI C cable, please note that not all connectors might fit the port.

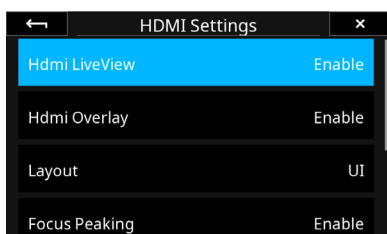

Enabling HDMI Output

Swipe up from the bottom edge of the IQ4 touch screen with a finger and select the menu icon. This will open the Menu system. Then select HDMI Settings, and set Hdmi LiveView to Enable.

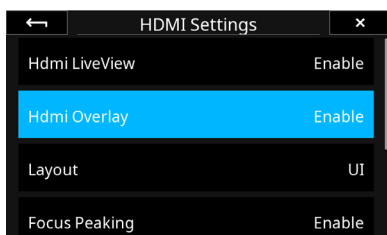

Display Histograms and Clip Warning

Live View via HDMI has the option to show a normal RGB Histogram, a RAW Histogram as well as a Clip Warning tool. To enable these, Select HDMI Settings > Hdmi Overlay and set it to Enable.

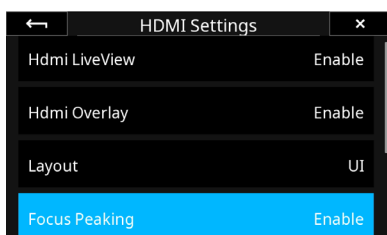

Display Focus Peaking

The Focus Peaking feature is a great aid to get the focus right as it will highlight the areas in the Live View feed that endetails high contrast and are thus likely to be in focus. Focus Peaking will update continuously as you adjust focus manually and is especially useful when you are zoomed into the image.

Ensure that Focus Peaking on HDMI is enabled by going to the menu and selecting HDMI Settings > Focus Peaking and set it to Enable.

Note that the feature looks for high contrast areas, so smooth zones like skin tones or a clear sky might not be highlighted, even if that part of the image is within the depth of focus.

You can change the sensitivity of the Focus Peaking feature by going to the menu and selecting HDMI Settings > Focus Peaking Threshold and change the level.

Showing the IQ4 UI over HDMI

The Layout UI option allows you to mirror what is currently shows on the IQ4 screen, including the menu system, on the HDMI target device like a tv screen. To enable this, Select HDMI Settings > Layout > UI. It is by default set to Layout.

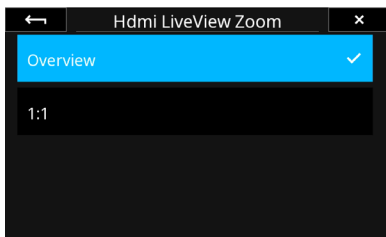

Changing LiveView Zoom

You can change the zoom level of the Live View feed with the hdmi LiveView Zoom option. By default, it is set to Overview which shows the full image. You can change this to view the Live View feed zoomed into the image at 1:1. To change this, Select HDMI Settings > HDMI LiveView Zoom > 1:1.

Controlling the HDMI in Capture One

The View Live functionality over a HDMI connection can also be controlled by Capture One. You will need to download and install version 11.2.1 to support the IQ4.

Once the IQ4 is connected to Capture One, go to the Camera Settings tool and open the IQ > HDMI panel. Here you will find the HDMI options.

Security Settings



The security code protection on the IQ4 is a safety measure to ensure that other people cannot gain access to the back without your consent. You can change the code as well as the level of protection by selecting **Menu > Security Settings** on the IQ4.

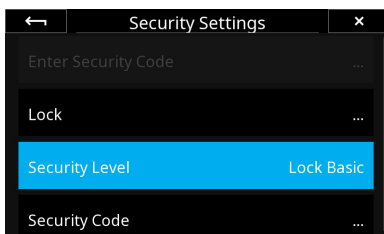

Changing Security Level

The IQ4 let you choose between four different security levels to suit your workflow the best. You select them by going to **Menu > Security Settings > Security Level**.

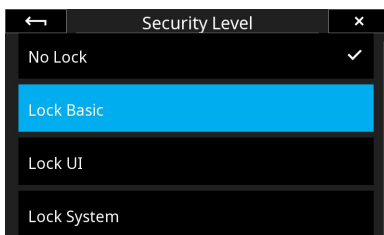

1. **No Lock.** This will disable the security code protection and is a convenient option when you are the only one with access to the IQ4.
2. **Lock Basic.** This option will ensure that nobody can update the firmware or restore the IQ4 settings to default without entering the security code. Those two options will be greyed out in the IQ4 menu system, but everything else will be available.
3. **Lock UI.** When you choose this option, you put the IQ4 into a capture-only mode. The user interface is locked (both the touch screen and the buttons), but it is still possible to capture images with the XF Camera Body or by tethering. Lock UI is useful when you want to lock all settings in a busy working environment or let another person shoot with the IQ4.
4. **Lock System.** This will lock the entire system, so that you will not be able to even capture an image without entering the security code first. This will also ensure that nobody can get access to the IQ4 by a tethering connection.

Note: You might need to select Security Settings > Enter Security Code and enter the security code to be able to change the Security Level.

Locking the IQ4

You can lock the IQ4 by swiping up from the bottom of the screen and tapping on the Lock icon.

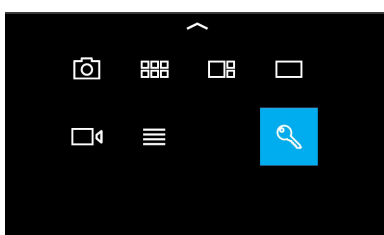

You can also do this by selecting IQ4 Menu > Security Settings > Lock. Note that this feature requires that you have set the Security Level to Lock UI or Lock System. Once you have done this, the Lock option will ensure that you - or other people - have to enter the security code to gain access to the IQ4.



Creating a new Security Code

You can create – or change – the security code on the IQ4 by selecting **Menu > Security Settings > Security Code**.

Enter the new four-digit code by tapping on the desired numbers on the touch screen and press on the green checkmark icon to accept it.

Recovering a locked IQ4

You have up to ten attempts to enter the correct security code after which the IQ4 will be locked. This is done to ensure against usage after for example theft.

If you are locked out of the IQ4 after ten failed attempts, you will need to contact Phase One Support in order to regain access. The IQ4 will show a security key that you have to provide to Phase One support in addition to the serial number of the IQ4; they will then guide you through the process to unlock the IQ4 with a special code.

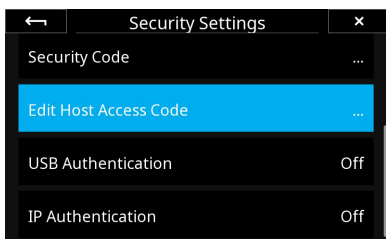

Tethering Access Code

It is possible to restrict tethering access to the IQ4 by setting an access code that needs to be entered in Capture One Pro before gaining access and control of the back. You can set whether this access code should be in effect for USB-C and/or IP (Ethernet and Wifi) connections separately. This feature needs Capture One 12.0.2 or later.

Select **Security Settings > Edit Host Access Code** and enter a four-digit code. Tap on the green checkmark to enable the code.

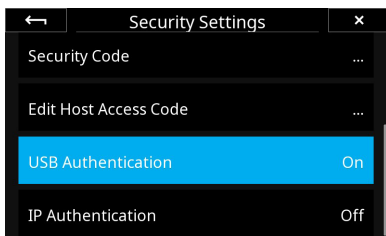

Then select **Security Settings > USB Authentication** and **Security Settings > IP Authentication** and set one of them or both to **On**.

It might make sense to have USB Authentication set to Off and IP Authentication to On, if you are shooting tethered via USB-C but want to ensure that others can't gain access to your IQ4 over WiFi (or remotely via an Ethernet connection).

Once the Host Access Code is enable, Capture One Pro will prompt you to enter the code when you try to gain access to the IQ4:

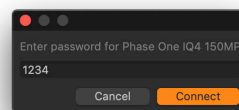

Capture One will remember the entered password even after you have disconnected the IQ4 or restarted the software. This is by design to ensure that you don't have to enter the same code several times during a busy shoot where you might want to run tethered capture on and off.

This also mean that you will have to change the Host Access Code if you want to ensure that new users of Capture One **on your computer** are prompted for an access key.

File formats and IQ Styles



Phase One has engineered a clever RAW file format compression named Intelligent Image Quality (IIQ). The IQ4 provides five different versions of the IIQ RAW format to ensure that you can always pick the best depending on whether image quality, size, or workflow speed is the most important. In addition to saving the captured images as RAW, you can also add a IQ Style and save a jpeg version.

You choose between the different RAW file formats on the IQ4 by tapping on the **File Format** icon on the **Camera Controls** screen or by selecting the **IQ4 Menu > File Settings > File Format**.

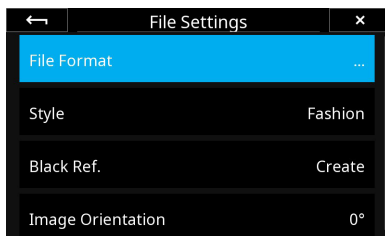

RAW file formats

The IIQ RAW files are saved either in a 16-bit format for highest image quality or in 14-bit when storage space and speed are of importance too. These are the five options:

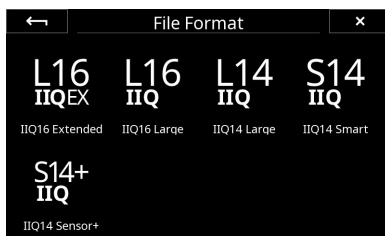

IIQ 16 Large A completely lossless compression format that saves the full 16-bit signal from the CMOS sensor. It offers excellent image quality when you want to take full advantage of the dynamic range of the sensor.

IIQ 16 Extended This format is an enhanced version of **IIQ 16 Large** as it provides an even lower base noise. It offers the very best in image quality when you need to extract extra detail in the shadows. As a consequence of the lower noise readout from the sensor, the frame rate is cut in half. It is recommended to use this format at base ISO 50 to enjoy the full benefits.

IIQ 14 Large Saves a 14-bit version of the RAW file using a completely lossless compression. It provides a smaller file size and faster capture rate compared to **IIQ 16 Large** and strikes a good balance between high image quality and size.

IIQ 14 Smart Is an intelligently compressed RAW file format, which strikes an excellent balance between file size and image quality. It can be used in almost all applications as the "Smart" compression is so efficient that it can be difficult to notice any difference over the **IIQ 14 Large**. However, since there is a very small loss of data, Phase One does not claim that **IIQ 14 Smart** is completely lossless, but what we call "near lossless".

IIQ 14 Sensor+ This Sensor+ RAW format is the perfect solution when you need a lower resolution file but still want to retain all the advantages of the RAW file. When selected, the Sensor+ RAW file will be exactly a fourth of the normal 151-megapixel resolution, giving you a 37.7-megapixel file. You will maintain the advantages of the RAW format, like being able to adjust white balance.

Capture One supports the **Sensor+** RAW files from the IQ4 150MP and they will work just like any other RAW files.

It is worth to point out that the Sensor+ technology is more advanced than just traditional pixel binning since it is happening directly on the IQ4 150MP sensor where the pixel data is organized in a unique way to create "super pixels". Also, the Sensor+ technology on the IQ4 150MP do not have any effects on the chosen ISO values.

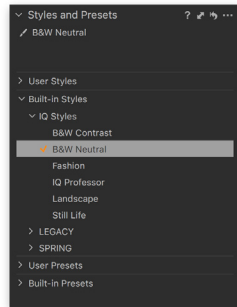
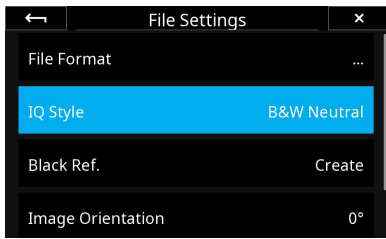

Capture One Inside IQ Styles

The IQ4 has an advanced image processing engine based on the technology from Capture One, called Capture One Inside. With this technology you can add styles to the captured images, letting you preview your favorite look instantly on the IQ4 screen instead of seeing the typically flat-looking RAW preview.

The selected IQ Style on the IQ4 will automatically be applied as a non-destructive metadata Style to the raw files during capture. When the files are imported in Capture One during tethering (or other means of image import), the Style will be automatically applied in the Styles and Presets tool. You can readjust the image adjustments based on the IQ Style to taste in Capture One, if need be. The selected Style on the IQ4 will also be baked into any jpeg file that is created on the back.

The IQ4 ships with six **IQ Styles** that each are optimized for specific image subjects or workflows.

1. **Landscape** aims to provide detailed landscape images in scenes with a high dynamic range. The style boost saturation slightly as well as recovering detail in the highlights and shadows. Finally, midtones are warmed slightly.
2. **Fashion** is optimized to ensure that you can evaluate that skin tones are neutral and smooth. Contrast is increased to add some pop to the image while saturation is reduced. In addition, the color balance applies a cold/warm split to the shadows and midtones.
3. **Still Life** provides an attractive alternative to the typical flat captures in Studio photography. The style applies a crisp contrast increase while lifting the brightness of the image without effecting saturation.
4. **B&W Neutral** replaces the “Black and White” view mode found in previous IQ digital backs. The effect basically mirrors enabling Black & White in Capture One.
5. **B&W Contrast** is a Black and White conversion style with some added contrast that makes the images pop more than B&W Neutral.
6. **IQ Professor** The Image Quality Professor’s choice of image adjustments. Please see the Image Quality Professor’s blog on phaseone.com for an explanation of the included image adjustments as this style is meant to showcase the possibilities of the IQ Styles and might change with a future firmware.

You choose between the different RAW file formats on the IQ4 by tapping on the **IQ Style** icon on the **Camera Controls** screen or by selecting the **IQ4 Menu > File Settings > IQ Style**.

Note: The Capture One engines in IQ4 and Capture One might render a slightly different look of the selected IQ Style, but the difference should be negligible.

Be aware that the selected IQ Style will not be applied to the Live View feedback as a fast refresh rate for the screen is prioritized.

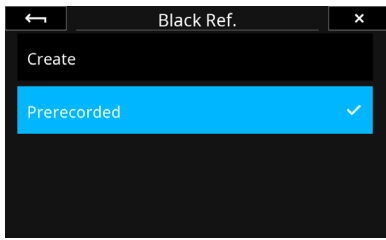

Fast, prerecorded Black Reference Frame

The new Prerecorded option for Black Reference Frame recording on the IQ4 150MP will provide a faster capture. The option is a parameterized, prerecorded method, thus removing the need for the black reference frame recording that is normally needed after each new image capture.

The option is particularly useful when shooting with the Electronic Shutter with technical cameras. Recording a black reference frame cannot be done fully automatically with technical cameras, since the IQ4 has no way of determining whether light is hitting the sensor or not. The new Prerecorded option will here lead to a much faster workflow.

Note that since the Prerecorded option is not based on your currently used camera settings and lighting conditions, it may not provide quite the same level of noise reduction at the pixel level as the traditionally recorded black reference frame.

It is currently not recommended to use the option for shutter speeds longer than 1/10 second.

You enable it by going to the menu and selecting **File Settings > Black Ref. > Prerecorded**. It is only available on IQ4 150MP models, not on the 100MP Trichromatic.

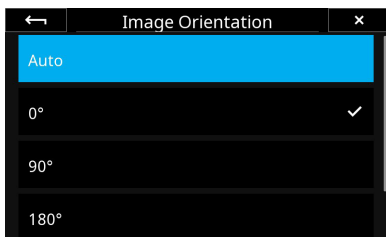

Setting image orientation

You can change the image orientation if the default setting doesn't work with the shooting view alignment. This can be useful if the XF IQ4 Camera System is pointing downwards or upwards, for example, and the images appear rotated the wrong way.

Go to the IQ4 Menu and select **File Settings > Orientation** and select the desired rotation.



Enter your Copyright information

You can enter your copyright information in order to save this as metadata in the files.

Go to the IQ4 Menu and select **File Settings > Copyright**. Then enter your copyright information and tap on the green checkmark to accept.

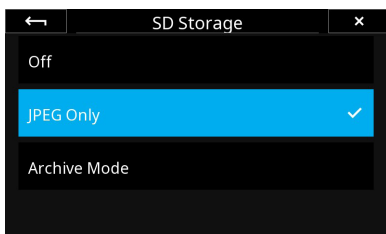

Saving a jpeg version

You can save a jpeg version on the SD card in addition to the RAW file version saved on the XQD card. This is done on the IQ4 by selecting **IQ4 Menu > Storage Setup > SD Storage > JPEG Only**.

Note that the IQ4 will need to save a RAW file to the XQD card to create the JPEG version from; it is not possible to only save a JPEG version of the captured image.

File Storage Setup

File Storage overview

The file storage system on the IQ4 is designed to be very flexible. You can choose to save the images on the memory cards in the IQ4 as well as on the computer when shooting tethered.

There are in essence 3 storage points:

1. XQD memory card
2. Tethering to computer
3. SD memory card

These can be combined as you wish. Note that the 3 different options for tethering (Ethernet, USB-C and Wireless) share the same setting, called Host Storage.

Storage Mode

You control how to store the image files by going to the IQ4 Menu, accessed by swiping up from the bottom edge of the IQ4 touch screen, and selecting **Storage Setup**.

By default, Storage Mode is set to **Auto**. This means that the IQ4 will automatically detect if a given storage is available and save the captured images there. If you have inserted a XQD card and is shooting tethering, you will get two copies of each captured image; one on the XQD card and one on the host storage computer.

You can control this behavior by changing the **Storage Mode** to **Advanced**. It will let you set the storage rule individually for the XQD card and the Host Storage (tethering to computer).

Note that the storage options for the SD card is a bit different and is covered on the next page in this chapter.

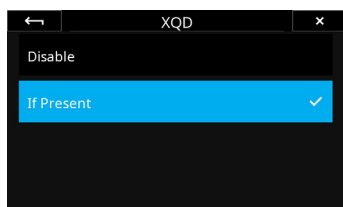
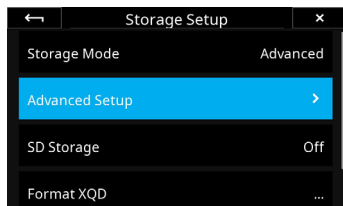
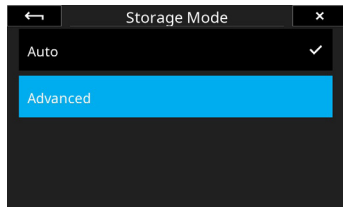

The options are the same for the **Host Storage** and the **XQD** card:

Disable. IQ4 will never save a copy of the captured image to the card or Host Storage even if it is available. Think of it as a way to turn the storage point off if you don't want to fill the XQD card, for example.

If Present. This is the default mode. IQ4 will save a copy of the captured image here if it detects that the card or Host Storage is available.

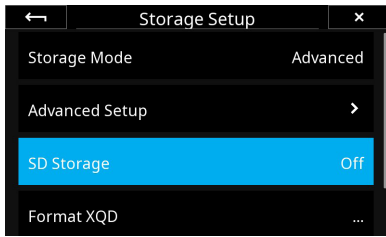

SD card Storage options

You can choose to either save a RAW file version or a JPEG version of the captured images on the SD card in addition to saving a RAW file on the XQD card. An XQD card must always be present to ensure the fastest possible operation.

You change the SD card storage options by going to the IQ4 Menu, accessed by swiping up from the bottom edge of the IQ4 touch screen, and selecting **Storage Setup > SD Storage**.

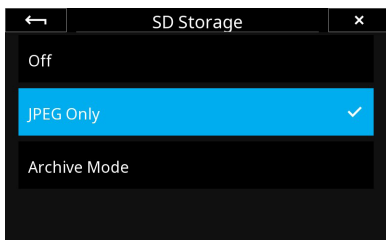

Saving a jpeg version

JPEG versions are reduced in resolution and can thus greatly speed up the workflow when needing to review the shots fast on location with clients or handing JPEG copies off to clients or an art director by giving them the JPEG versions on a SD card.

You enable the option to save a jpeg file version on the IQ4 by selecting **IQ4 Menu > Storage Setup > SD Storage > JPEG Only**.

Note that the IQ4 will need to save a RAW file to the XQD card to create the JPEG version from; it is not possible to only save a JPEG version of the captured image.

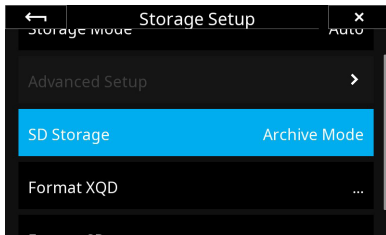

Saving a RAW backup on the SD card

If you want to save a RAW file to the SD card as a backup measure in addition to the RAW file saved on the XQD card, select the **Archive Mode** option in the **SD Storage** menu.

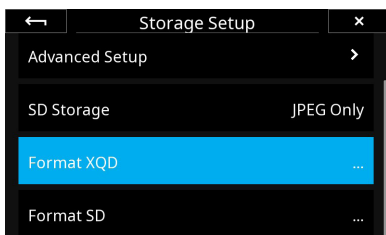

Formatting the memory cards

You can format the XQD or SD cards independently. Just go to the IQ4 menu and select **Storage Setup > Format XQD** or **Storage Setup > Format SD**. A warning is displayed as a safety measure, so just tap on **OK**.

If the IQ4 reports that it cannot format the XQD card, please do a reformat of the card on your computer first.

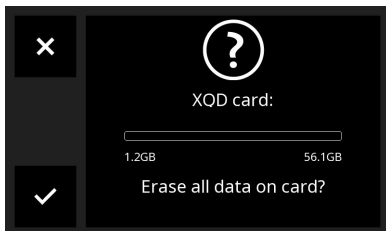



Tethering Connections

The XF IQ4 Camera System provides two different options for powerful, fast, and reliable tethering via cable. In addition there is an option for wireless tethering, allowing you to choose the best possible workflows for your specific needs.

This chapter will cover how to set up and take advantage of the different tethering connections on the IQ4. The options are:

1. Ethernet
2. USB-C
3. Wireless

Gigabit Ethernet connection

The Gigabit Ethernet connection on the IQ4 allows for long cables (up to 90 meters).

Connection for tethering

Connect the supplied Gigabit Ethernet cable to the RJ45 port on the IQ4 and the other end to a network port on a router or switch. Connect another Ethernet cable between the computer and the router or network.

Launch Capture One version 11.2.1 (or later). IQ4 can automatically establish an IP connection over Ethernet (or WiFi) to Capture One on your computer via the built-in Bonjour feature. There is no need to configure the IP connection; you just select the IQ4 as the connected camera system from drop-down menu in the Camera tool in Capture One, and you are ready to start your capture session.

Note! The automatic IP connection feature works natively on the macOS, but if you're working on a Windows pc, you need to have Apple's Bonjour installed. This is done by downloading and installing either iTunes for Windows or Bonjour Print Services for Windows from Apple.

Be aware that while it is possible to connect the IQ4 directly to your computer with just an Ethernet cable, it is not recommended as the router will handle the network connection (like assigning IP addresses) automatically. If you connect directly, you will have to enter some network details manually.

Ethernet Cables

The IQ4 requires a Category 6a (or better) of highest quality to deliver a fast and reliable tethering experience. Use the supplied 5-meter cable or buy a longer cable as accessory. It is possible to use a length of up to 90 meters.

Power delivery

The IQ4 supports the Power over Ethernet (PoE) which can deliver sufficient electric power to keep the XF IQ4 Camera System running smoothly during normal usage without having to recharge the batteries.

Please read the **Power Connections** chapter for more information about the PoE power delivery options on the IQ4.

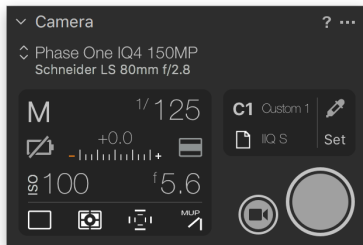



USB-C connection

The IQ4 have a native USB-C connection that provides fast tethering. It is based on USB 3.1 Gen 1 which can transfer data up to 5 Gbps.

Connection for tethering

Use the supplied USB-C to USB-C cable (3 meters) to connect the IQ4 to a computer with a USB-C port like a newer MacBook Pro. Make sure that you insert the end with the transparent cover into the IQ4 port in order to make a firm connection that can't wiggle during use.

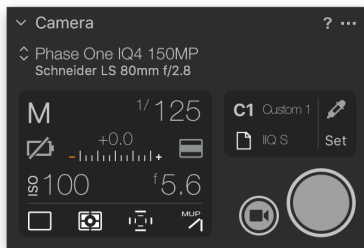

Launch Capture One version 11.2.1 (or later), and the XF IQ4 Camera System will connect automatically. The IQ4 will show up in the Camera tool in Capture One, and you are ready to start your capture session. (See a later chapter for more information on shooting tethered with Capture One).

USB-C Cables

The supplied USB-C cable and the USB-C connection on the IQ4 is compatible with all standard USB-C connections, including the ports on newer Mac's that have additional support for Thunderbolt 3. They are also compatible with the USB 3.1 Gen 2 standard (data transfer up to 10 Gbps.). If you have a computer with an USB 3.0 Type A port, use the supplied USB-C to Type A cable.

We highly recommended that you use the supplied USB-C cables, but if you try to use another please note that USB cables on 3 meter should be a marked "Active". They have a chip built-in to amplify the signal. Otherwise the connection can become unstable.

In case you need to use longer cable distances, Phase One recommends that you use the Gigabyte Ethernet option instead of using USB-C as the Ethernet connection will provide superior reliability with longer cable lengths.

USB-C Power Delivery

While USB-C cables can carry sufficient power to keep the XF IQ4 Camera System running without having to recharge the batteries, not all computer USB-C ports will deliver that level of power.

Please read the **Power Connections** chapter for more information about the USB-C power delivery options on the IQ4.

Wireless connection

You can do wireless tethering on the IQ4 over Wi-Fi without any need for cables. The feature will facilitate a fast preview of the captured images in Capture One while a transfer of the full-sized raw image can happen in background. The feature requires that the captured raw files are also saved to a memory card in the IQ4 in order to provide a fast and reliable workflow.

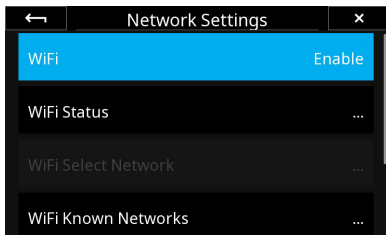

Connection for WiFi tethering

IQ4 can automatically establish an IP connection over WiFi to Capture One on your computer via the built-in Bonjour feature. To activate the Wireless connection on the IQ4, swipe up from the bottom of the screen and select the IQ4 Menu.

In the Menu, select **Network Settings**, and set **WiFi** to **Enable**.

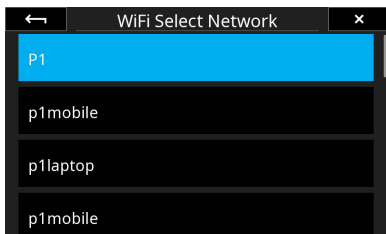

Once you have enabled WiFi on the IQ4, choose **Network Settings > WiFi Select Network**. The IQ4 will now scan for any available wireless networks and show them as a list. Select the WiFi network that you have access to on your computer. If the network requires a password, you will be prompted to enter it on the touch screen.

Note that all secure networks have a password, and the IQ4 will remember it the next time you select the same wireless network. Once connected, close the menu screen by tapping on the cross in the top-right corner.

The IQ4 will now connect to your wireless router. Ensure that your computer is connected to the same wireless router, and launch Capture One version 11.2.1 (or later).

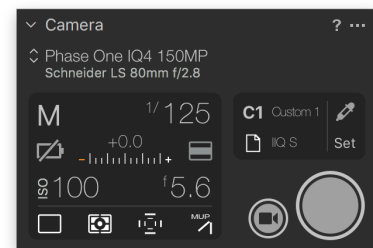

Next, you just need to select the IQ4 as the connected camera system from drop-down menu in the **Camera** tool, and you are ready to start your capture session.

Note! The automatic IP connection feature works natively on the macOS, but if you're working on a Windows pc, you need to have Apple's Bonjour installed. This is done by downloading and installing either iTunes for Windows or Bonjour Print Services for Windows from Apple.

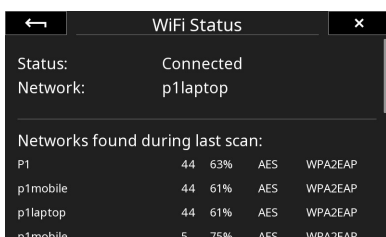

You can get an overview over the quality of the available wireless networks by choosing **Network Settings > WiFi Status**. The IQ4 will show the signal strength in percentage, and this can be useful to help choosing the wireless network that will provide the best connection.

Checking for Image Transfer

It will take time to transfer RAW images over your WiFi network and show up in Capture One, so here is a way to check whether the images are indeed being transferred: Swipe down from the top edge of the screen to reveal the Status Menu. At the bottom by the WiFi icon, a status text like this will be shown if there are images in flight: **Connected Images Pending: 2 81% (2,8 MB/s)**. Once this process is completed, the images will show up in Capture One.

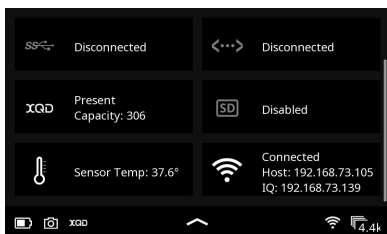

You can check whether the IQ4 has been assigned a DHCP Address by swiping down from the top Status Bar to reveal the full Status Menu. Under WiFi, the IQ4 will show two different IP addresses: **IQ** is the IP connection between the IQ4 and the router, while **Host** is the IP connection between the host computer and the router.

The **IQ** DHCP Address can be used if you need to establish a connection to the IQ4 manually. If no IP number is displayed, the router has not assigned one, and the IQ4 cannot establish a connection.

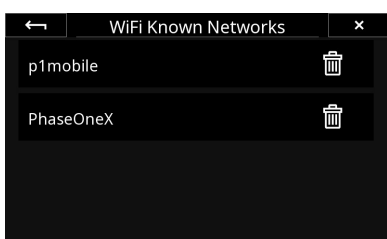

Managing Known WiFi Networks

The IQ4 will remember a wireless network and its access codes once you have connected to it. If you want to delete this network for future use, select **Network Settings > WiFi Known Networks** in the IQ4 Menu. Then tap on the trash icon to delete the network from the list.

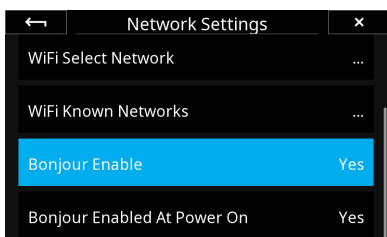

Ensure Bonjour is enabled

Bonjour is enabled by default to ensure that IQ4 can easily and automatically establish an IP connection.

If you for some reason want to disable Bonjour, select **Network Settings > Bonjour Enable** in the IQ4 Menu and change it to **No**.

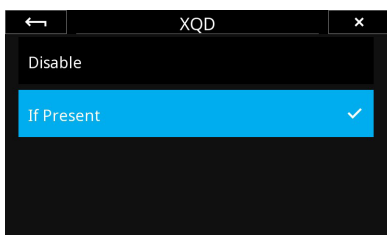

Save image copy to memory card during tethering

Note that in addition to transferring the RAW images to your computer while shooting tethering you can also save RAW copies to a memory card on the IQ4. This backup will provide extra security.

By default, the IQ4 will automatically detect if a XQD card is available and save copies of the captured images there too. Please read the File Storage chapter on how to change the Storage Mode on the IQ4.

Power Connections

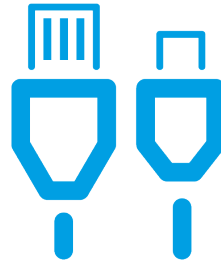

Power Connections Overview

The XF IQ4 Camera System is designed to provide a number of flexible powering solutions by either Power over Ethernet, devices supplying power over USB-C cable or by using the XF Power Supply accessory.

Power over Ethernet (PoE)

The IQ4 supports the Power over Ethernet (PoE) which can deliver sufficient electric power to keep the XF IQ4 Camera System running smoothly during normal usage without having to recharge the batteries. The attached router/switch obviously needs to support Power over Ethernet (PoE) for the power delivery to work.

Note that if you have Live View running (or are using Live View over HDMI) for a prolong period, the IQ4 might use more power that can be delivered via PoE and the batteries will thus not be charged.

If your router/switch or computer doesn't support Power over Ethernet, you can add a Power over Ethernet injector device to the network. The PoE-injector plugs into an electric outlet and adds the power to the Ethernet cable loop. Make sure that the injector point is added between the IQ4 and the router/switch or computer to work.

The PoE standard supports up to 15.4 watts of output power, but in practice a POE Router or Injector and the cable connection will provide around 13 watts of power. As already mentioned, this will be enough to keep the XF IQ4 Camera System running during normal usage without the need to recharge the batteries. However, if you are using Live View constantly, the XF Power Supply and the USB-C power delivery options can provide more power to the IQ4 so consider using one of those for this specific usage case.

Power over USB-C

XF IQ4 Camera System will intelligently draw as much power as possible over the USB-C connection, which can be plenty to keep the system running without having to recharge the batteries. This is done on the IQ4 by using the USB Power Delivery (PD) standard to negotiate with the power supply on the attached USB-C device (it can in theory draw up to 16V and 3A).

The IQ4 is thus capable of drawing plenty power over USB-C to keep the XF IQ4 Camera System running under heavy usage with Live View while also being able to charge the batteries. This means that USB-C connection can provide notable more power than Power over Ethernet, but please be aware that few computer USB-C ports are actually able to deliver this level of power. As an example, the USB-C port on a newer MacBook Pro will provide 5V with a maximum current of 1.5A, which translate into a maximum power of 7.5 Watt.

Even if the USB-C port on your computer only provides 7.5 W, it will obviously prolong the use of the XF IQ4 Camera System before having to recharge the batteries. The IQ4 might not use more than 5-6 watts when idle, so a bit of

charging the batteries in between shots is feasible. However, the best way to provide sufficient power delivery from the port is to buy a USB-C device with its own power supply like the OWC USB-C Dock which can supply plenty of power via a USB-C cable.

You can also buy a USB-C power supply and plug it into the USB-C port on the IQ4, and it will serve as a power supply. As an example, you can use the power supply that comes with newer MacBook Pro's to power and charge the IQ4. The IQ4 will automatically take as much power as possible.

Using a USB-C Power bank

You can attach a USB-C based power bank to the USB-C port on the IQ4 to deliver power. The IQ4 will be using the USB Power Delivery (PD) standard to negotiate how much power it can draw from the power bank. Note that it can accept up to 16V as a max, so if your power bank can supply 20V, 9V and 5V, the IQ4 will draw 9V.

External XF Power Supply

You can get power delivery from the XF Power Supply accessory by connecting it to the 12 pin multi connector port on either the XF Camera Body or the IQ4.

If you need to have both a cable release and the XF Power Supply attached using the same 12 pin multi connector port, the Phase One Break Out Box (B.O.B.) accessory will solve that as you can connect the XF Power Supply to the B.O.B. accessory.

Note that IQ digital backs older than IQ4 uses an 8 pin multi connector port and thus need an adapter to use the XF Power Supply or the BOB accessories. With the IQ4, the port has been aligned to use a 12 pin multi connector like on the XF Camera Body.

Power input priority for the XF IQ4 Camera System

1. **External XF Power Supply:** If the XF Power Supply is connected to the XF IQ4 Camera System through either of the 12 pin multi connector ports, this power source will be used.
2. **Power Over Ethernet:** If you have a Gigabit Ethernet connection and no XF Power Supply is connected, the Power over Ethernet feature will be the preferred power source.
3. **USB-C:** If neither the XF Power Supply or Power over Ethernet is available, power deliver over USB-C will be used.
4. **PowerShare:** If none of the above power options are available to the system, the IQ4 will rely on the intelligent PowerShare feature and thus draw power from battery in the XF Camera Body, or vice versa. Ensure that **Power Management > Power Share With Camera** is set to **On** for this to work.

Charging LED indicators

The LED on the back of the IQ4 will indicate the charging status of the battery:

- An **orange pulsating** light indicates that the battery is charging normally.
- A **green-yellow pulsating** light indicates that the battery fully charged.
- A **red pulsating** light indicates that the battery is close to being depleted but is charging. It is not recommended to run the IQ4 with this battery level, and the IQ4 might in fact not power on.

Power Management Options

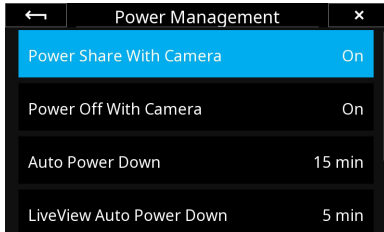

Power Share With Camera

The Power Share feature will allow the XF Camera Body and IQ4 to share power between the two. This means that you can charge both batteries with a single power source connected to either the IQ4 or the XF Camera Body. The **Power Share With Camera** feature is **On** by default.

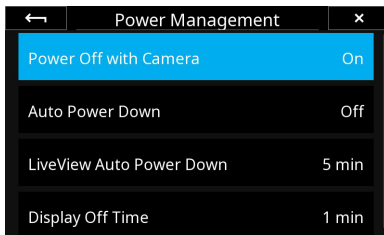

Power Off with Camera

This option will power the IQ4 off when you turn the XF Camera Body off. It is set to **On** by default. You can set it to **Off** if you want the IQ4 to stay on regardless of the XF Camera state.

Auto Power Down

This option will ensure that the IQ4 powers down after a period without use to preserve battery power. It can be set from 5 minutes and up to 2 hours, and the feature can also be turned off. It is set to 15 minutes by default.

LiveView Auto Power Down

You can set the IQ4 to disengage from Live View after a period without use to preserve battery power. The period is set to 5 minutes by default. It can be set from 20 seconds to Off.

Display Off Time

This option will ensure that the screen on the IQ4 will turn off after a period without use to preserve battery power. It is set to 1 minute by default. It can be set from 5 seconds and up to Always on.

Hot swapping batteries on the XF IQ4

The Power Share feature in the XF IQ4 Camera System enables the XF Camera and IQ4 to share power from each other's batteries. This will allow you to hot swap one of the batteries without the camera system shutting down, but please follow this procedure when doing so:

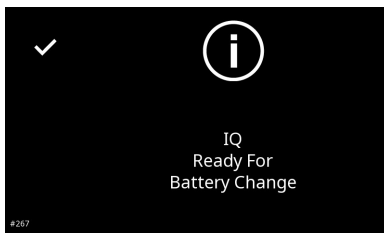
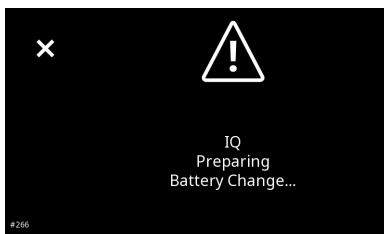

1. Ensure that **Power Management > Power Share With Camera** is set to **On**.
2. Open the battery door on either the IQ4 or the XF Camera Body. Do **NOT** remove the battery just yet.
3. The XF IQ4 Camera System will now show a dialog informing you that either the IQ4 or the XF is preparing the battery change.
4. Wait until either the IQ4 or the XF is telling you it is ready for the battery change. Then remove the battery and insert another.
5. Close the Battery door. The dialog box will now close, and the camera system is ready to use again.

Power Share notes

- Please be aware that power sharing between the IQ4 and XF is temporarily suspended when using Live View (or Live View over HDMI). The power sharing functionality will resume as soon as you exit Live View or HDMI and the Camera System is idle again.
- If the XF IQ4 Camera System is turned off, you will only be able to charge the battery on the device that you have connected the power supply to. Both the XF Camera and IQ4 need to be turned on for the Power Share feature to work.

Custom White Balance

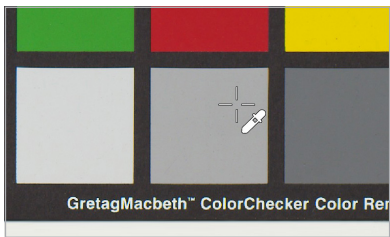

White Balance Picker

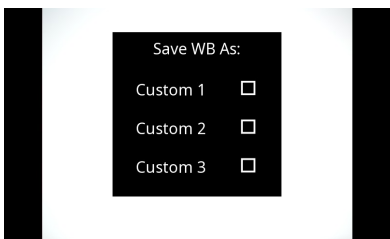

White Balance Custom save

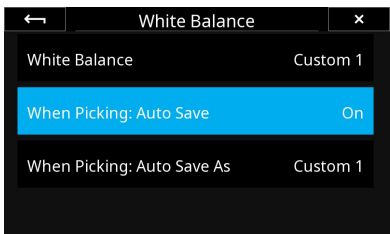

White Balance Auto Save

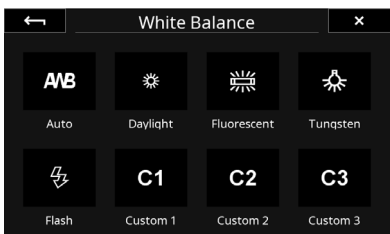

White Balance preset options

Creating a Custom White Balance

Creating a custom White Balance setting on the IQ4 is achieved from either a captured image when in the Viewer or from the live view feed in Live View. It is recommended to capture a reference white balance image like a Gretag Macbeth Color Checker, or QP-Card displayed in the image under the intended light source.

Swipe in from the left and tap on the **White Balance Picker** icon to activate the tool. Then drag the White Balance Picker icon with your fingertip to the point on the image that you want to reference as a neutral tone (a gray patch, or a light gray neutral area in the image). The tool will now automatically adjust the white balance based on the color cast in that spot.

Next, tap on the White Balance Picker icon on the screen and you will get the option to save the white balance adjustment as either **Custom 1**, **Custom 2** or **Custom 3**.

The setting is automatically saved and all subsequent captures will use this white balance setting.

Saving the Custom White Balance automatically

It is possible to save the selected white balance automatically on the IQ4, saving you the step to select either **Custom 1**, **Custom 2** or **Custom 3** (see above). This is done by going to the IQ4 Menu and selecting **IQ Settings > White Balance > When Picking: Auto Save** and then choosing **On**. The white balance will now be applied and saved automatically when you deactivate White Balance Picker tool.

Note that you will not get the option on the screen to select whether the new white balance setting should be saved as either Custom 1, Custom 2 or Custom 3. This is controlled in the menu setting **White Balance > When Picking: Auto Save As**, so ensure that you select the desired white balance custom slot (C1, C2 or C3) when using the **Auto Save** feature.

You can also access the additional White Balance settings by long-pressing on the White Balance icon when in the Viewer or Live View.

Selecting a Custom White Balance Setting

You select the desired Custom White Balance Setting from the Camera Controls. Tap on the top right button of the IQ4 until it is selected, then press the White Balance icon.

Now you can choose the custom white balance by tapping on C1, C2 or C3. If you have only stored one custom white balance, select C1.

NOTES:

White balance and custom white balance settings are only necessary for a representative rendering of the color when displayed on the touch screen of the IQ4 or when saving JPEGs in addition to raw files.

The raw files will contain the white balance settings for correction in Capture One, so capturing a reference white balance file with a gray card under the intended light source will speed up the workflow.

Prism Viewfinder Display and Functions

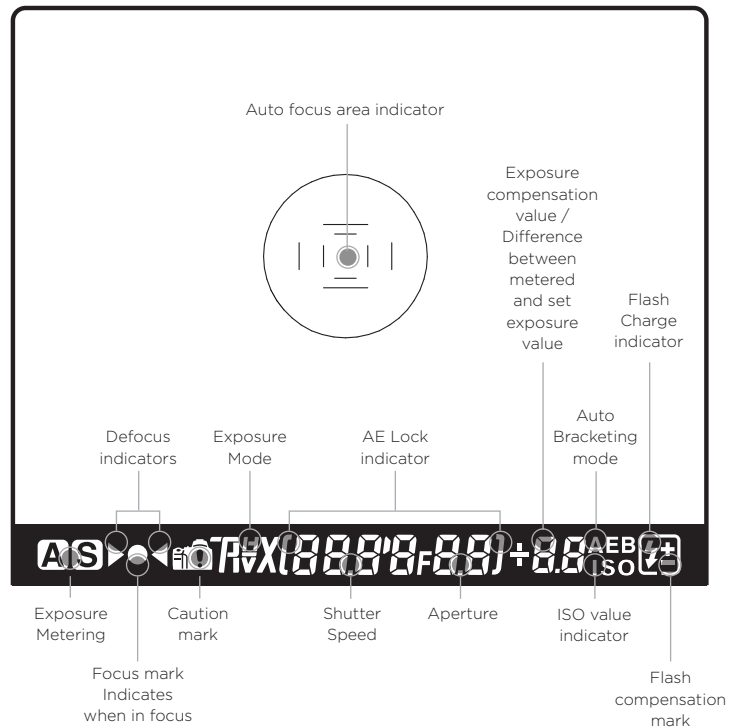

Viewfinder Overview

Autofocus Area

The XF is equipped with autofocus sensor indicators in the center of the frame. Two rectangular AF areas are displayed on the focusing screen, one within the other, that corresponds to the Average and Spot AF mode options available with the camera. Surrounding the AF area is a central spot that denotes the Spot metering area only.

The AF area in use is highlighted on the XF Top Touch Screen. To change the AF area mode, touch the icon, and select the appropriate area option from the screen.

Viewfinder Display

The XF has a comprehensive viewfinder display. However, for clarity only relevant information is shown. Please refer to the image above for an explanation of each possible display settings.

Eye-piece Diopter Adjustment



Eye-piece Diopter Adjustment

Adjustment is required for comfortable viewing if you wear corrective lenses. To start the procedure, first switch the lens to MF and defocus the lens manually. Point the camera at a bright, evenly lit area such as the sky or a white wall. Look through the viewfinder and turn the diopter adjustment dial on the side of the prism viewfinder until the AF area frames and Spot metering circle on the focusing screen are in sharp focus. Turning the diopter adjustment dial counter-clockwise adjusts for near-sightedness, clockwise for farsightedness.

If you normally wear eyeglasses for distance viewing, or close-up work, and want to continue to wear them while using the camera, follow the procedure described above. Alternatively, if you prefer to remove your eyeglasses while working with the camera, please repeat the method of adjustment above without wearing them.

If the built-in diopter is not sufficient, you may require an optional diopter correction lens:

Part# 70278 Diopter correction lens DE402 (Near Sighted, -5 to -2 diopter)
Part# 70279 Diopter correction lens DE403 (Far sighted, 0 to +3 diopter)

For replacement of the supplied diopter correction lens, please order:
Part # 70277 Diopter correction lens DE401 (Standard, -2.5 to +0.5 diopter)

Removing the Eyecup

The eyecup supplied with the XF as standard is suitable for users who intend to use the camera either with or without eyeglasses. To replace the factory diopter, release the eyecup by pulling the small metal latch on the top towards you. Then slide the eyecup up and out of the eyecup rail.

Changing the Viewfinder Diopter Lens

To change the diopter correction lens, first remove the eyecup then gently slide the diopter lens down, and out of the diopter rail. Reinstall the new diopter lens, and make sure it is positioned back correctly with the small click-lock tab facing up on the left-hand side.

Viewfinder eyecup release nub



NOTE:

If there is dirt or dust on the lens surface, remove it with a blower or sweep it off gently with a lens brush. If there are fingerprints or dirt on the lens surface, wipe them off with a piece of clean, soft gauze. Using solvents could discolor the correction lens frame.

XF Camera System Settings Overview



XF Camera Body basic settings

The XF is delivered from the factory preconfigured with a set of default settings. The XF Camera Body can be reset to the default settings from the Camera menu, Load Setup > Restore to Default.

Shutter Speed

Shutter Speed can be adjusted using the Front Dial.

Aperture

Aperture can be adjusted using the Side Dial.

ISO Selection

ISO can be adjusted using the Rear Dial. ISO speed options are dependent on which IQ back is attached. Auto ISO speed range can be selected by touch, and is also dependent on the IQ Digital Back attached.

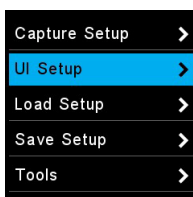

UI Setup Menu

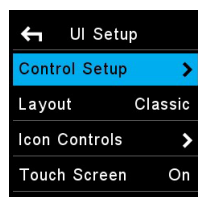

Control Setup

Any one of the three dials may be reconfigured to adjust Exposure Compensation in Auto mode (Off by default). This option is selected by pushing the Rear Key to enter the Camera menu and selecting:

UI Setup > Control Setup > Front / Rear / Side Dial > In Auto > ExpComp.

All three dials turning direction may be reversed by pushing the Rear Key to enter the Camera menu and selecting:

UI Setup > Control Setup > Front / Rear / Side Dial > Direction > CCW (default) / CW.

Please note the symbol (/) denotes an optional setting.



AF Drive Single

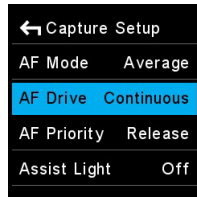

AF Drive Continuous

AF/MF

Autofocus or Manual focus operation is selected using the physical Auto/Manual collar on the lens.

AF Drive Mode

The AF drive mode can be changed by pushing the Rear Key to enter the Camera menu and selecting Capture Setup > AF Drive > Single (default) / Continuous.

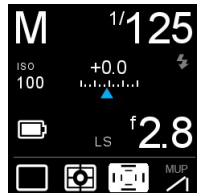

AF Area Mode

AF Area Mode

The autofocus area can be set to Average (default), Spot or HyperFocal by selecting the icon on screen and choosing the required mode by touch or the Side Dial.

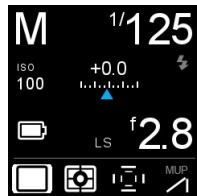

Capture Mode

Capture Mode

The capture mode can be changed by selecting the icon on screen and choosing the mode by touch or the Side Dial. You have six options to choose from: Single (default), Continuous, Vibration Delay, Bracketing, Delayed and Manual (Bulb/Toogle).



Exposure Mode

Exposure Mode

Manual (default), Aperture Priority, Time (Shutter) Priority and Program exposure modes can be changed by selecting the icon on screen and adjusting by touch or the Side Dial.



Metering Mode

Metering Mode

Select one of three modes for reflected, ambient light only. Choose between Matrix (default), Center and Spot, by selecting the icon on screen and choosing the required mode by touch or the Side Dial.

Note modes depicted by screen icons can be selected directly by touch or by pressing the front Top Key and then by scrolling through the various icons using the Front Dial.

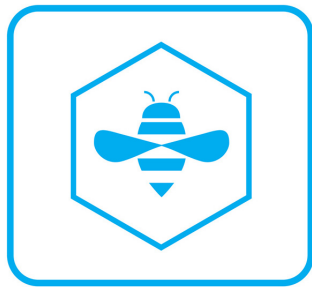

Honeybee Autofocusing System

The Honeybee Autofocus Platform is designed with a custom processor coupled with a dedicated high-resolution CMOS sensor. This combination creates a unique floating-point architecture and a fully programmable interface, making the Honeybee Autofocus Platform easy to expand, update and customize.

Honeybee Autofocus Platform versions

In mid 2017, Phase One introduced an optional upgraded version of the Honeybee Autofocus Platform, called HAP-2. The new HAP-2 sensor has increased sensitivity and improved dynamic range, making it superior to the HAP-1 sensor in low light situations and on low contrast targets. This means that the XF Camera with HAP-2 installed is capable of using auto focus in available light situations where it previously could be challenging. (With HAP-2 the minimum EV for auto focus is reduced from 4.0 to 1.5). Apart from the increased sensitivity, all AF functionality in the XF Camera is available with both the HAP-1 and the HAP-2 AF sensor.

Note that it is possible to have your XF Camera upgraded to the newer HAP-2 focusing unit by a Phase One service center, if desired. Please contact your Phase One Partner for details.

If you're in doubt of which version of the Honeybee Autofocus Platform your XF Camera have installed, press the Top Rear Key and select About. The information screen will either state HAP1 or HAP2 under the AF item.

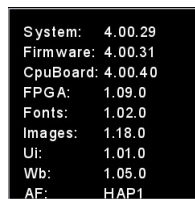

Installed HAP version

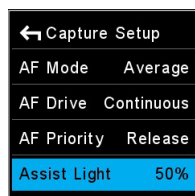

Focus Modes

Focus Modes

There are two autofocus mode (AF Drive) options available from the XF Camera Body: Single and Continuous. The camera is delivered with the AF Drive mode set to Single and the AF Priority function set to Release (release priority) by default. The focus point is determined by the AF Area mode displayed as inner and outer brackets on the focusing screen. When contrast or light levels are too low, the AF Assist Light may be activated. It is set to Off by default (from the camera menu, select Capture Setup > Assist Light > On).

AF Drive mode setting

To change between Single and Continuous AF, press the Rear Key to enter the Camera Menu and select Capture Setup > AF Drive > Single / Continuous, using the Front and Rear Dials.

Single (AF)

Selecting the Single AF drive mode activates the AF servomotor to focus the lens once, after pressing the shutter release button halfway. After focus has been achieved, maintaining pressure on the shutter button at this half-pressed stage locks the focus, allowing the photographer to recompose the image. Pressing the shutter release button to the second stage releases the shutter. Autofocus is reactivated by releasing the button and half-pressing again.

Continuous (AF)

Choosing the Continuous mode, with the shutter-button pressed halfway, the AF servomotor focuses the lens while the Honeybee autofocusing system continues to monitor the subject. If the subject moves after being acquired, the

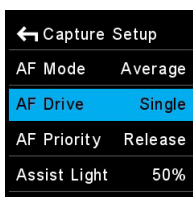

Single (AF)



Continuous (AF)

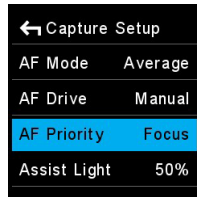

AF Priority setting

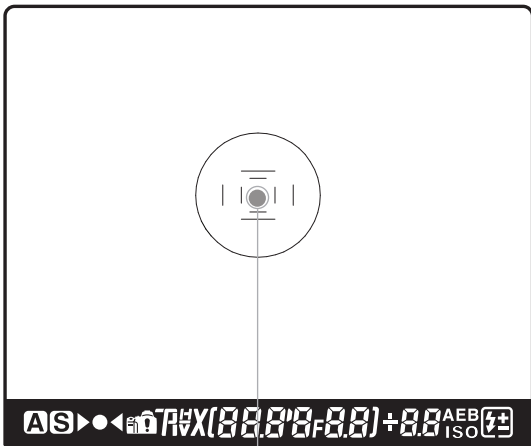

Auto focus area frame

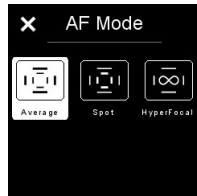

AF Area Mode setting

lens will be refocused to follow the subject.

AF Priority setting

The AF priority can be set to prevent the shutter from being released until the subject is confirmed as in focus. To change AF Priority, press the Rear Key to enter the Camera Menu and select Capture Setup > AF Priority > Release / Focus.

AF Area Modes

Autofocus precision and accuracy are essential to deliver sharpness at high-speed, and so Phase One developed a proprietary autofocus sensor for the XF Camera, the Honeybee Autofocus Platform, and equipped it with a dedicated processor. For improved focus precision, the XF Camera replaces individual line and cross-type sensors in favor of a single CMOS sensor containing a million pixel elements arranged in a multiple honeycomb-shaped pattern. For optimal autofocus with a variety of subjects and scenes, the Honeybee Autofocus Platform sensor has two AF Areas, Average and Spot. Note the AF system is located in the mirror-box and operates when either the prism viewfinder or the waist level finder are attached.

Average AF Mode

The Average mode covers the largest area for focusing and takes advantage of all one million (1MP) pixel elements. The Area covered is displayed in the center of the viewfinder and is represented by the outer-brackets etched onto the focusing screen. The Average mode can be used with long lenses and small Apertures in low light levels. Choose this mode where manual focusing may be difficult during hand-held capture, or when photographing a moving subject.

Spot AF Mode

The Spot AF mode covers a much smaller area in the center of the viewfinder, and is indicated by the narrower brackets on the focusing screen. Select this mode when working with wide-angle lenses, or for pinpoint focusing with longer focal length lenses.

AF Area Mode setting

To change from the default Average area to the smaller, Spot AF area, select the AF mode icon from the Top Touch Screen and then switch between the settings directly, using touch (or the keys, as described elsewhere). The mode selected is shown on the Top Touch Screen.

NOTE:

If the lens ring is set to AF pressing the shutter release button activates autofocus. With the subject covered and acquired by the selected AF area, the focus confirmation indicator lights in the viewfinder when focus has been achieved. Audio confirmation is off by default but to turn this option on, press the Rear Key to enter the Camera Menu and select UI Setup > Audio > Focus Confirm. > On.

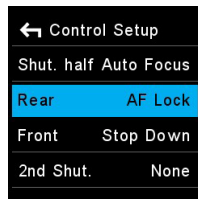

Assigning AF Lock

AF-Lock

When the camera is set to either the Single shot or Continuous AF Drive mode, the focus position can be locked, which is useful for off-center subjects. The AF-Lock function is not assigned to a control button by default. To re-configure the Front or Rear User button, or assign the feature to the secondary shutter release button, press the Rear Key and select UI Setup > Control Setup > Rear / Front / 2nd Shut > AF Lock.

1. Focus on the subject using the Single shot or Continuous AF Drive mode.
2. Press and hold the assigned button to lock the focus.
3. Recompose the subject in the viewfinder.

NOTE:

You will achieve higher focus accuracy for off-center subjects by using the dedicated focus recompose feature called AF+, which is described in a later section.



AF/MF selector ring

Manual Focus (MF)

Manual focus is achieved by switching the AF/MF selector ring on the lens from AF to MF. Note autofocus cannot be performed if the lens is set to MF. The point of focus can be determined by the AF Area mode using the focus indicators in the viewfinder display, or by eye using the focusing screen.

NOTE:

The AF/MF selector ring on the lens can help you to rapidly switch between AF (Autofocus) and M (Manual) using your left hand, without having to remove your finger from the shutter release button.

AF Compensation with Focus Trim

It is possible to fine-tune the AF sensor's accuracy with two methods. You can either use a fully manual procedure as described on this page, or use the semi-automatic way with the Focus Trim Tool as described in the following chapter. Phase One recommends that you use the Focus Trim Tool.

The Focus Trim feature adjusts the plane of focus forwards or backwards by the set amount and the focus point will then be adjusted by this trim amount every time autofocus is initiated.

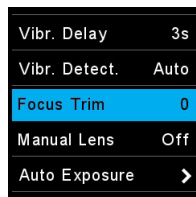

Focus Trim setting

Adjusting Focus Trim manually

Phase One recommends making adjustments using the Spot AF mode with the camera and intended lens on a tripod, either at the location (under the anticipated lighting conditions), or at a similar distance with as close to the anticipated conditions as possible.

To set the amount of front or back focus compensation, press the Rear Key to enter the Camera Menu, and select Capture Setup > Focus Trim > - / 0 / +. The amount can be adjusted in steps of ± 5 pts.

Make initial adjustments in multiples of three (± 15 pts.) or five steps (± 25 pts.) and then fine-tune in smaller steps until the desired result is achieved.

Setting negative (-) Trim values moves the focus point forwards of the default (factory set) focus point (0). Selecting positive (+) Trim values moves the focus point backwards of the default focus point (0). Therefore, if the focus point is in front of the intended point of focus, continue to adjust by increasing the positive (+) value.

To remove the compensation settings, set the Trim value to zero (0).

Focus Trim Tool

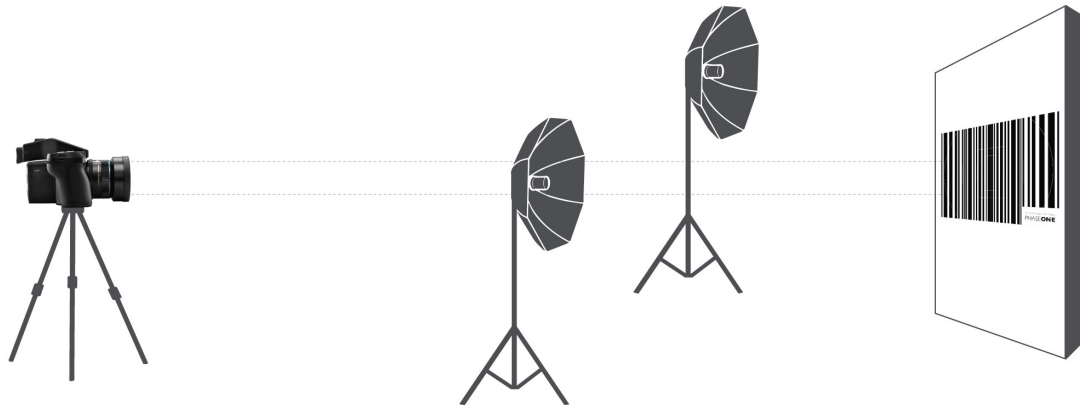

This tool will guide you through the process of obtaining the optimal Focus Trim, making sure that the focus system will achieve the best possible accuracy.

Your XF Camera and lenses are manufactured to the highest precision standards, however, even slight differences in the tolerances of the autofocus system can lead to the focus being a touch off. The Focus Trim Tool removes this issue by shifting the plane of focus slightly forwards or backwards until a perfect compensation is achieved and stored within the focusing system.

The Focus Trim Tool is a five-step guide that makes the process both easy and reliable. The tool is disabled by default from the top touch screen because it is not supposed to be used regularly. This means that you need to activate it in the XF menu system under Tools or alternatively enable it under UI Setup > Tools Enabled if you want to be able to use the swipe action to activate it.

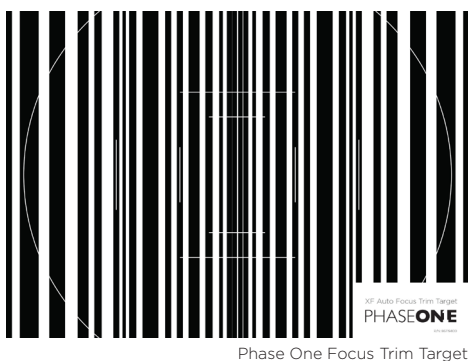

Step 1: Preparation and setup

Use the supplied Phase One Focus Trim Target or download it from www.phaseone.com and print it. Mount the XF Camera on a tripod and make sure that it is perpendicular to the focus target.

You will get the best result by using the same distance between the camera and the Focus Trim Target that you would normally shoot with. For a more universal setting, adjust the distance so that the markers in the viewfinder more or less matches the corresponding white markers on the A5-sized Focus Trim Target.

Next, make sure that the XF Camera is setup correctly by using the largest aperture of the lens, for example, f/2.8, setting the Drive Mode to Vibration Delay, metering to Spot, and AF Mode to Average Focus. Pay attention to the exposure if you are in Manual mode, and adjust the shutter speed until you have a slight overexposure.

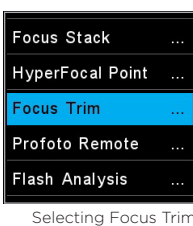

Once you are ready, select the Focus Trim Tool as explained above. Then press Start Tool.



Not enough light on focus target



Focus target is too far away

The XF Camera will now automatically check whether all the conditions for a reliable focus trim process are met. It will, for example, check whether the autofocus target has a proper distance, that the amount of light is sufficient and whether the camera can do an auto focus on the target.

The tool will warn you if certain conditions are not fulfilled, like the light level on the focus target being too dim. If you get any warning, you should fix those, and start the Focus Trim Tool again.

Step 2: Adjusting focus manually

If all conditions are met, you are prompted to fine-tune the focus manually until the target appears as sharp as possible. This can be done using either Live View on the IQ Digital Back or connecting the XF Camera System to Capture One Pro.

2a: Using Live View on the IQ Digital Back

Tap on the Live View icon in the Focus Trim Tool to activate it on the IQ Digital Back. Zoom to 100% on the screen in order to see the focus target clearly. It is important that you zoom into the same center area on the target that the XF Camera has focused on.

Adjust the Side Dial and Front Dial until you have achieved the maximum sharpness. Start with the Side Dial, as it will adjust focus in larger 10x increments, then use the Front Dial for fine-tuning in the smaller 1x increments.

Once you have achieved maximum sharpness, exit Live View on the IQ Digital Back by pressing Live View icon again. Then proceed to step 3.

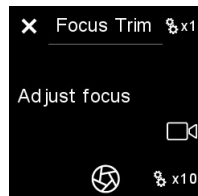

Adjust focus manually

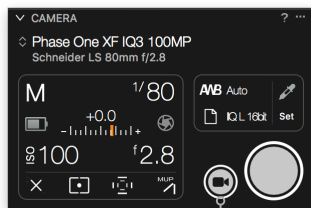

Start Live View

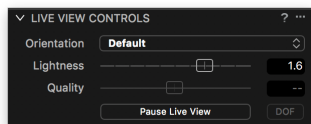

Brighten the live view feed with Lightness

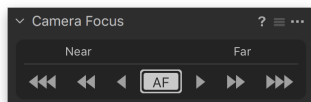

Using Camera Focus to adjust focus manually

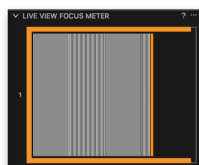

Live View Focus Meter Tool

2b: Using Capture One Pro

It is easier to do the manual focus fine-tuning step using Capture One Pro for a couple of reasons. Adjusting the focus from the software will ensure that the camera doesn't vibrate during the action and will provide a steadier Live View feed. You can also zoom in closer with Capture One Pro and use the Live View Focus Meter Tool to help achieve the optimal sharpness.

In Capture One Pro, go to the Camera Tool under Capture Tool Tab and click on the Start Live View button. Make sure that you zoom into the same center area as the XF Camera has focused on. You might need to adjust the Lightness slider in the Live View Controls to brighten the Live View feed.

Use the Camera Focus Tool to adjust focus manually by clicking on the arrow buttons until you have achieved the maximum sharpness. You should first use the buttons with double-arrows, and then fine-tune focus by using the single-arrow buttons.

The Live View Focus Meter Tool can help you to achieve the optimal sharpness. Click on the Focus Meter icon and place the frame over the central focus area. Click on the buttons with the single-arrow in the Camera Focus Tool until the orange border is as far to the right as possible while it is also filled with white stripes. This will be the point of optimal sharpness.

Once done, close the Live View window in Capture One Pro.



Start automatic trim adjustment



Measuring the focus trim value

Step 3: Start automatic trim

Press the Start Trim or the Top Front Key. The Focus Trim Tool will now measure whether the camera can detect focus reliably with the adjustments you have made in step 2. If all is well, the progress bar will be green, and the Focus Trim Tool will move to the next step where you can save the focus trim.

If the measurements fail, the bar will turn red. This can be caused by low light on the focus target, and you should rerun the process.

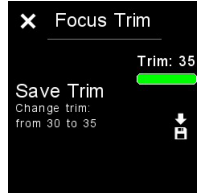

Saving the Trim value

Step 4: Saving the auto focus trim value

Save the obtained Focus Trim value by either pressing the Save icon on the touch screen or by pressing the Top Rear Key.

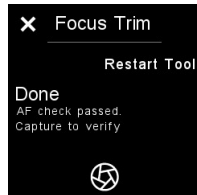

Verifying the trim value

Step 5. Done

It can be a good idea to verify the new focus trim value by capturing an image while still in the Focus Trim Tool. This is done by pressing the Rear User button. Then check the sharpness of the image on the IQ Digital Back by zooming in to 100%.

If you want to rerun the Focus Trim procedure, press the Restart Tool or the Top Front Key. The tool is closed by pressing the cross in the upper-left corner.

Autofocus & Recompose mode / AFR Mode

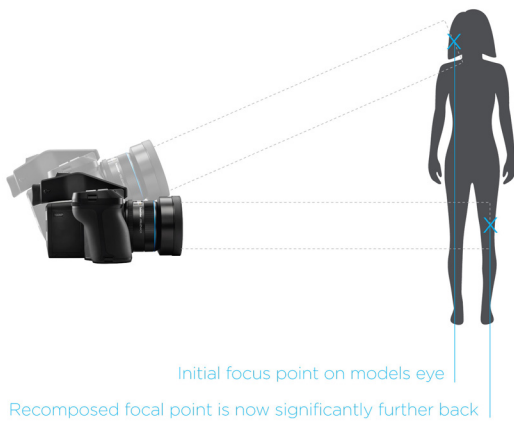

The XF Camera has a unique auto focus feature called AFR Mode which will ensure the intended subject remains in focus even after you lock focus and then recompose the image.

Under normal circumstances, the plane of focus will shift when you change the angle of the camera for recomposing after having locked focus. This will render the intended subject slightly out of focus, which is especially notable if you are working with a shallow depth of field. A classic example of this is found in portrait photography where you lock focus on the subjects eye, using the center auto focus point, and then recompose the frame so the subjects eye is no longer in the center of the image. The resulting image will result in the eye then be slightly soft as the plane of focus is moved (behind the eye or in front of the eye).

Using AFR Mode compensates for this movement of the focus point, making sure that the eyes - or another subject - retains focus after the frame is recomposed. The XF Camera uses internal sensors to calculate the compensation, measuring both the distance to the subject and the degree to which the camera is moved from the point where focus was acquired to the point where you capture the image.

This feature is optimized for speed and performance in a professional working environment. As such, the compensation that AFR Mode applies to your captured image is anticipated based on your preceding captures. In this way AFR Mode can effectively learn your specific technique and improve as you continue to capture. The initial act of focusing on a subject and recomposing the frame is steadily improved while using this auto focus feature, providing (optional) audio and visual feedback to verify success.

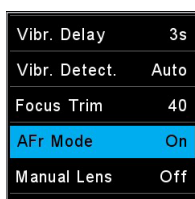

Enabling AFR Mode



AFR Mode active



Vibration Delay warning

Enable AFR Mode

You can enable AFR Mode by pressing the Top Rear Key and selecting Capture Setup > AFR Mode. Then adjust the Side Dial to turn the feature On. Please note that the lens will now refocus as a part of a calibration; this is a normal behavior.

Once you have enabled the AFR Mode, an AFR icon will show up on the top touch screen to remind you that the feature is active.

Note that Vibration Delay cannot be used in conjunction with the AFR Mode because both features rely on the 3D movement sensors in the XF Camera. If you have activated Vibration Delay, you will get a warning message, asking you to turn it off in the Drive setting.

Using AFR mode to recompose

Once AFR mode is activated, autofocus is invoked by pressing the shutter button halfway down (unless autofocus function is assigned to a separate button). When you have locked focus on the target, simply recompose and press the shutter button all the way down to capture the image. The XF Camera will automatically adjust the plane of focus for you, based on your anticipated movement, prior to capturing the image.

Feedback on focus accuracy

The XF Camera can give you visual and audible feedback to reflect the success, or failure, it was able to measure in maintaining focus on the subject after recomposing. The focus indicator in the viewfinder will blink once if the operation of AFr was correctly anticipated and verified, while both the focus dot and the arrow indicators will flash quickly if the camera cannot verify that accurate focus and recompose was achieved.

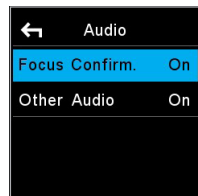

Enabling focus confirmation beep

If you have enabled Focus Confirm under Audio, the XF Camera will also give you audible feedback. You will get a normal sounding beep if the focus and recompose operation was measured as a success, while you will hear a longer sounding warning beep if the camera cannot verify that accurate focus was achieved.

Note that the audible feedback is only an indication that the focus plane adjustment, applied to the focus of the lens, matched the anticipated movement of the XF Camera. This tool is designed to learn the movements of the XF Camera over the course of a shoot, and therefore the more you repeat the same movement within a sequence of images, the greater the success. The initial capture from when the camera is turned on, may be imperfect in terms of AFr success, but the subsequent images will apply and fine tune the adjustment to your movement. It is suggested that you pair this audible feedback with the Zoom to Focus to visually confirm success.

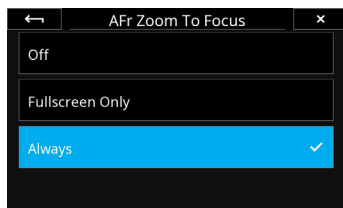

Enabling AFR Zoom to Focus

Checking for correct focus

If you want to check quickly whether the subject is indeed in proper focus, you can setup the preview image on the IQ4 to help you out. The preview image has an option to automatically zoom into the point of focus instead of showing the entire capture, making it much faster to review the focus accuracy.

This is done on the IQ4 by choosing Menu > **IQ Settings** > **Preview** and then under **AFr Zoom To Focus**, selecting **Always**. The feature is set to **Off** by default.

If you only want AFR Zoom To Focus to work when you are in the **Viewer** or **Camera Controls** (but not in the **Browser** or **Tools Viewer** modes), select the **Fullscreen Only** option.

Note that the AFR Zoom To Focus feature might zoom into an area that is slightly off the point where you locked focus. This is not a sign that the AFR mode has miscalculated the focus compensation, but it is always a good practice to judge the focus accuracy by viewing the main subject on the IQ4 screen.

Supported lenses for AFR mode

Currently (as of XF Feature Update #4 SR2) the following Schneider Kreuznach Blue Ring lenses are supported for Autofocus & Recompose mode:

- 35mm LS f/3.5
- 45mm LS f/3.5
- 55mm LS f/2.8
- 80mm LS f/2.8
- 110mm LS f/2.8
- 120mm LS f/4.0 Macro
- 150mm LS f/2.8
- 150mm LS f/3.5
- 240mm LS f/4.5

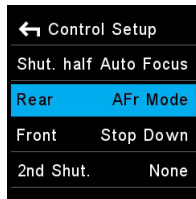

Assigning AFr Mode button

Assigning a custom button to toggle AFr mode On and Off

You will probably find it useful to be able to turn the AFr mode on and off quickly, depending on the subject to hand. This can be done by assigning a custom button to act as AFr mode toggle. Press the Rear Key and select UI Setup > Control Setup. Then select the button that you want to customize, and turn the Side Dial until you have selected AFr Mode.

Here we have assigned the Rear User Button as the toggle, but you can use any of these buttons:

- Shutter Release Button
- Secondary Shutter Release Button
- Front User Button
- Rear User Button
- External Shutter Release (B.O.B.)

Working with hyperfocal distance

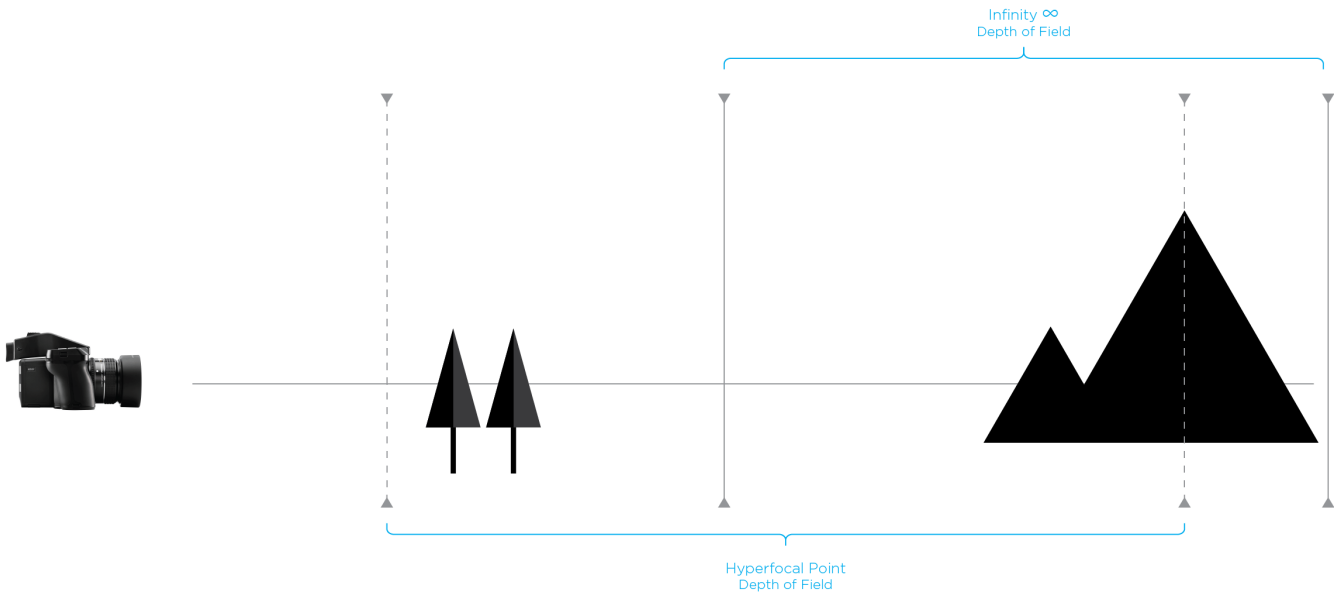

What is hyperfocal distance

An important element of landscape photography is ensuring that all of the key elements within your composition are sharp. This can often include foreground objects that are a matter of meters from your camera, as well as background elements that can be kilometres away. One way to ensure that the entire frame is in focus, 'acceptably sharp', is to ensure that the depth of field extends from the foreground to infinity. To do this, you need to focus at the 'hyperfocal distance'. For a given focal length and Aperture, there will be a distance where setting your point of focus will result in the entire scene being within the depth of field.

How you set it per tradition

For many photographers the best way to optimize the point of focus is visually. Try first focusing on the most distant object within your scene, then manually adjust the focusing point as close as possible while still retaining an acceptably sharp background.

Many use a rule of thumb, which states that you should focus roughly 1/3 of the way into your scene in order to achieve maximum sharpness throughout. While this is sometimes helpful, it is rarely optimal; the precise distance actually depends on many factors, including subject distance, Aperture and focal length.

Hyperfocal distance on the XF Camera System

The XF Camera System can store one specific focus distance for each lens. An obvious use of this functionality is to store the hyperfocal distance for the lens, at your preferred working Aperture. This focus distance can be recalled at your convenience.

On the XF Camera System this hyperfocal distance is represented by a “hyperfocal point” corresponding to the physical point or marker many photographers set on their lens to easily adjust focus to the hyperfocal distance. The XF hyperfocal point is measured in absolute “MCUs” (Motor Control Units). An internal scale, calibrated to the accuracy of the geared lens focus mechanism.

Saving an XF hyperfocal point

Entering the XF Hyperfocal Point mode - via The XF Rear Key > Tools > Hyperfocal Point

Please NOTE that this always assumes that the lens is in AF mode.

Use dials and save an XF hyperfocal point

In the HyperFocal Point Tool, now use the Front and Rear Dials to fine-tune your focus and depth of field for your scene. The Front Dial and the Rear Dial control the focus movements measured in “MCU” increments. The Front Dial: +/- MCU, the Rear Dial: +/-10 MCUs. The electronic control of the lens movements secures optimal positioning accuracy.

Please NOTE that it is important NOT to manually touch the focus ring of the lens in this mode, as this will interfere with the precision of the electronically controlled focus mechanism.

When you have reached an optimal hyperfocal point, it is stored by pressing the save icon of the Hyperfocal Point screen.

Use focus bracketing and save an XF hyperfocal point

To assist an accurate setting of the Hyperfocal Point, a special focus bracketing function is available. It allows for capturing a sequence of 5 shots: the base shot focussed at your current Hyperfocal Point, complemented by four extra shots, focussed using the hyperfocal increment “Step” your selected MCUs, multiplied -2, -1, +1, +2.

It is strongly recommended to work tethered to Capture One, to accurately inspect each image for focus and depth of field, and secondly to get the Hyperfocal Point “call-out value” for each of the images in the capture sequence (In metadata).

When you select the image, which has the focus and the depth of field best covering your scene, you dial in the Hyperfocal Point call-out from Capture One in the Hyperfocal Point screen, and store the Hyperfocal Point by pressing the save icon of the Hyperfocal Point screen. You may continue the process with a finer increment, now working from your new best image as the base shot.

The captured images can also be inspected on an iPad, connected to an IQ2 or IQ3 XF Camera System via wifi and Capture Pilot, the Phase One wireless camera control software. The images can also be inspected on the XF rear screen. However, neither the iPad-monitor nor the XF rear screen can display the specific Hyperfocus Point “call-out value” of the images. These must be calculated manually.

Using the Hyperfocal Point

Once the Hyper Focal point is set, it is possible to select hyper focal mode as an AF mode (spot, average or hyperfocal). If Hyper Focal is selected, an activation of the AF button will move the lens to the stored value. Note that you can also assign a user button to activate the stored HyperFocal Point directly. This is done by selecting the Rear Key > UI Setup > Control Setup and then selecting the button you want to assign it to.

It is highly recommended to assign a different button than the shutter half-press to “Auto Focus” - this is done with the Rear Key > UI Setup > Control Setup.

The hyperfocal mode is not stored persistently. Once the XF is turned off it jumps back to the previous value.

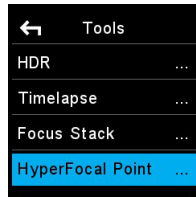

HyperFocal Point Tool

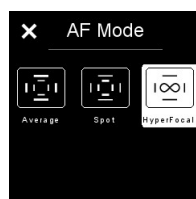
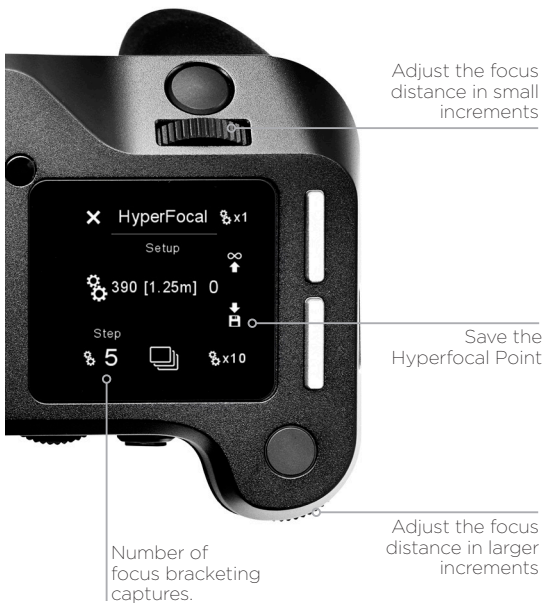
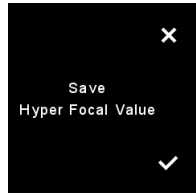

Select HyperFocal Point

XF Camera System Capture Modes

The Phase One XF Camera Body has six drive modes; Single, Continuous, Vibration Delay, Bracketing, Delayed and Manual. Each mode is accessed from the drive mode screen after tapping the drive icon on the XF top screen, or from the duplicate XF screen on the IQ Digital Back after selecting XF Menu > Camera Controls...

Single capture

One image will be captured when fully pressing the shutter release button. Holding the button down will NOT result in additional captures. To make a subsequent capture, the shutter release button must be released then pressed again.

Continuous capture

The camera will capture images continuously to the fastest possible frame rate with the release button held down. Note frame rates are dependent on the IQ Digital Back model and file format selected.

Vibration Delay

The mirror is locked up automatically for reduced vibration and the shutter is released. In this mode, the XF Camera System uses data from its seismographic sensor to monitor the low vibration drive where a capture delay secures stability for the capture.

The maximum capture delay is set using a long press of the Vibration icon in Drive screen or by pressing the Rear Key on the XF top screen and from the menu: select Capture Setup > Vibration and then toggle the Rear Dial to the wanted delay.

The delay can be adjusted from 0.5 to 8 seconds or even set to Infinity. When the Vibration Delay time set in seconds is reached, the camera will always capture the shot regardless of the vibration level. With Infinite Vibration Delay, the XF Camera will wait until the vibration is low enough or you cancel the capture. Note that you can also initiate the capture manually at any time during the countdown by tapping on Capture Now on the XF top screen.



Vibration Delay mode

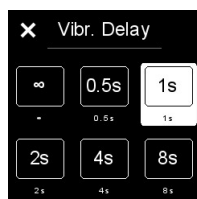

Vibration Delay options

Exposure Bracketing

This automatic function delivers a series of captures based around a metered exposure setting, irrespective of the Exposure mode selected. The XF Camera Body will automatically capture three frames in succession by default: one 1-stop under, one at the metered exposure and one 1-stop over. Bracketing steps can be selected up to 5.0 EV apart, with the option for selecting between 2-7 captures in total.

Press the Drive icon in the main screen to display the Drive modes, and then press and hold the Bracketing icon to reveal the Bracketing functions. From that dedicated screen, select the number of captures and the difference in EV between them using the rear and Side Dials.

Note to reduce vibration and to fine-tune the metered exposure setting respectively, the bracketing function can be used in conjunction with the Low Vibration mode , which can be turned on or off directly from the bracketing screen.

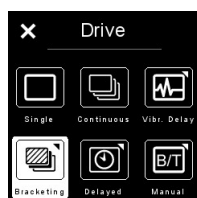

Exposure Bracketing



Bracketing with Normal Drive



Bracketing with Vibration Delay



Delayed capture mode

Delayed

In addition to the Vibration Delay feature, you also have the option of setting a specific delay timer manually. This is done by a long press of the delay icon on the drive screen, and then choosing the desired value in seconds with the Side Dial.

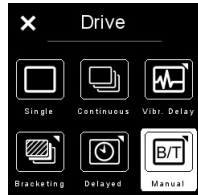

Manual (Bulb/Toggle)

Manual (Bulb/Toggle)

As a final capture mode, you can choose to do a fully manual exposure with the Bulb mode or Toggle mode. In the Bulb capture mode, you hold the shutter button down as long as you want the exposure to last. In Toggle mode, you initiate the exposure by pressing the shutter button once and then stop the exposure again with another press of the shutter button. The top touch screen will show the length of the capture while using this mode. Note that after you have stopped the capture, a black frame calibration will take place automatically, and the top touch screen will display a timer countdown while the black frame is recorded.

You can choose between Bulb and Toggle mode by either turning the dial assigned to shutter speed, or by a long press on the Manual icon in the drive screen popup menu. Instead of displaying the shutter time, the touch screen will now show either B or T.

Please note that when Manual drive mode is selected, all remote capture functions are treated as Toggle, even if Bulb is selected. So if the capture button is activated from Capture One, the first tap opens the shutter, and the second tap closes the shutter again.

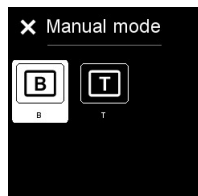

Choosing between Bulb and Toggle

XF Camera System Exposure Modes

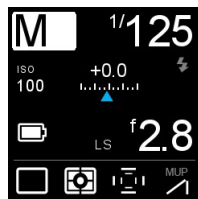

Exposure Mode

Changing the Exposure Mode

Exposure is controlled manually with the XF delivered set to M (Manual) by default, with the Shutter Speed set by the Front Dial, and Aperture values selected by the Side Dial. ISO settings are selected by the Rear Dial. However there are two additional semi Auto exposure modes available: Av (Aperture Priority), Tv (Shutter Priority), and a full Auto P (Program) option.

In the standard Classic screen layout, the Exposure Mode can be changed by tapping the icon on the top touch screen, followed by a selection of the preferred mode or followed by toggling the rear or Side Dial.

In the semi-Auto modes, where the Aperture or Shutter Speed is selected automatically by the camera, the redundant dials may be customized to automatically select the Exposure Compensation function instead. See Exposure Compensation setting for more details.

ISO Setting

ISO sensitivity can be set either by scrolling the Rear Dial on the XF Camera Body or by selecting ISO with the top right key of the IQ Digital Back. Settings are automatically transferred between the IQ Digital Back and the XF Camera Body. The ISO range available is dependent on the IQ Digital Back model attached to the system.

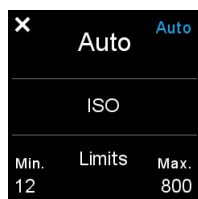

Auto ISO Setting

Auto ISO Setting

An auto ISO option is useful in rapidly changing lighting conditions. On the XF Camera Body, the function is accessed by pressing the ISO icon on the top screen, or from the XF Camera Body menu on the IQ Digital Back. Note there's no access from the back's ISO shortcut button or upper right key. The Auto ISO screen displays minimum and maximum ISO limits to set a working range, for example, to limit noise. To set the Function to Auto, select OFF > Auto. To set the limits, scroll through the range using the Rear and Side Dials. No confirmation is required, as the settings are saved automatically. Return to the main screen by the touch the cross (X) mark or half-press the shutter release button.

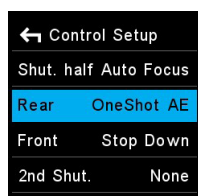

OneShot AE

OneShot AE Exposure Mode

The OneShot AE mode is a very useful feature when you work in Manual exposure mode and quickly need to switch the XF Camera to automatic exposure to get a shot. In essence, OneShot AE will turn on automatic exposure temporarily for the next capture only by pressing an assigned key. Once the shot is taken, the camera will revert to the exposure settings that you had chosen beforehand.

First, you need to assign a button to use for OneShot AE. This is done by pressing the rear key and selecting UI Setup > Control Setup > and choosing the desired button. Then turn the Rear Dial until you have selected OneShot AE.



OneShot AE options

Next, setup whether Aperture, Shutter Time and/or ISO should be automatically controlled by OneShot AE. Pres the rear key and select Capture Setup > Auto Exposure > OneShot AE. Then select Aperture, Shutter Time or ISO and turn them On or Off with the Rear Dial. Please note that you can choose any combination and allow the camera to change all three values automatically or just one to obtain the right exposure. By default, the XF Camera is set to only change the Shutter Time, but you can, for instance, change the OneShot AE feature to only change the ISO value to obtain the proper exposure.

With everything setup as needed, just press the assigned button to active the OneShot AE for the next shot.

Exposure Compensation



AF Priority	Focus
Assist Light	Off
Shutter	LS Priority
ES 50/60Hz Filter	Off
EV Steps	1/3 Step

Exposure Compensation Steps

Using Exposure Compensation

The Exposure Compensation function is available primarily for the semi-auto and auto exposure modes (Av, Tv, and P), but it can also be used in manual exposure mode. Compensation can be set from -5 to +5 EV in either 1/3, 1/2 or 1 EV increments. By default, exposure compensation is applied in 1/3 EV increments. (To change this to 1/2, or 1 EV increments, press the top rear key and then select Capture Setup > EV Steps > 1/3, 1/2 or 1. Note that this setting is global.)

The EV value applied is displayed on the top screen and in the viewfinder display and remains fixed, regardless of the number of captures. To remove any exposure compensation applied, access the function again and set the value to 0 (zero).

Exposure Compensation can be selected from the camera's top-screen by touch or the Front Key and applied by scrolling through the value (EV value) using the rear or Side Dials.

Exposure Compensation Quick Set in Auto

In the semi-auto modes, where either the Aperture or Shutter Speed is set automatically by the camera, the redundant dial may be reconfigured to modal operation, for setting the Exposure Compensation function for example. The change in function is applied automatically when selecting the semi-auto or auto exposure modes. Access the XF menu from the top screen (or IQ screen) and select UI Setup > Control Setup > Front / Side Dial > In Auto > ExpComp.

The Rear dial, by default, alters the ISO sensitivity, but if this function is subsequently set to Auto (by touching the ISO icon, and selecting Off > Auto), the dial can be reconfigured in the same way as the others to adjust Exposure Compensation in the Auto ISO mode.

Long Exposure

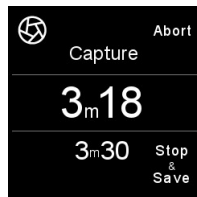

3.30 min exposure at 3.18 min

The IQ4 determines the long exposure capabilities of the XF IQ4 Camera System, and all relevant settings are synchronized between the IQ4 and XF Camera Body. The IQ4 is capable of long exposures up to 60 minutes in duration, selected directly from the Front Dial of the XF. No special Exposure mode is required when using the Phase One XF, however Manual exposure mode is recommended.

Select the Aperture using the Side Dial. Compose using the viewfinder or Live View, focus and then trigger the shutter release. The shutter remains open for the allotted time and the top screen of the XF will show the elapsed time (in secs). Shutter speeds longer than 1.0 second automatically change the leaf shutter option (if available) over to the camera's integrated focal plane shutter.

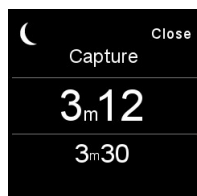

Black frame capture at 3.12 min

Noise Reduction (Dark Frame Subtraction)

In order to minimize noise, an additional dark frame is captured for the same duration as the capture and subtracted from the original exposure. This is fully automatic, and there is no need for you to intervene. After the elapsed exposure time, the screen displays a count-down in seconds during the dark frame subtraction, and the icon in the top-left of the screen changes from an iris to a crescent moon to denote the operation. The Stop and Save option ends the exposure and automatically starts the dark frame capture. If you selects Abort, the image is not saved. When the noise reduction (dark frame) process is finished, the camera is ready to capture another image.

Electronic Shutter (ES)



It is possible to capture the images using the Electronic Shutter which provides advantages for a number of capture scenarios and extends the workflow possibilities when using technical camera applications.

The Electronic Shutter has several advantages. Since there are no vibrations from a mechanical shutter, it is easier to capture the finest details and fully enjoy the high resolution of the IQ4 150 MP. Another advantage of using the Electronic Shutter is that there is no mechanical wear when shooting a very large number of photos. Additionally, you can capture an image completely silently.

Note that it does take a noticeably longer time to read the entire image from the sensor when using the Electronic Shutter rather than the mechanical shutter. The full read-out time is typically a half second on the IQ4 150MP (three times longer on the IQ4 100MP Trichromatic), and as a consequence, large moving subjects, like a car, will be distorted in the image. For the same reason, Electronic Shutter only support a very slow flash synchronization, but it is a great choice when doing studio work or copy stand photography using continuous light.

The Electronic Shutter is also very useful for landscape images, where there are only small local movements in for example leaves, trees or waves. These kinds of movements are captured instantly at the specific location and will thus not represent a problem. We highly recommend using Electronic Shutter with a tripod.

Please note: Bulb and Toggle function on XF will not work in ES mode.

AF Mode	Average
AF Drive	Single
AF Priority	Release
Assist Light	Off
Shutter	ES only

Enabling the Electronic Shutter from the Top Touch Screen

Enabling the Electronic Shutter

The Electronic Shutter can be enabled via the XF Camera Menu on the top touch screen by selecting Capture Setup > Shutter > ES only. You can also enable it on the IQ4 by selecting XF Menu > Capture Setup > Shutter Mode > ES Only.



Using Electronic Shutter (ES) without the XF Camera Body

When using the Electronic Shutter on the IQ4 with, for instance, a Technical Camera instead of the XF Camera Body, you can control the shutter speed and other exposure settings via the Camera Controls on the IQ4 touch screen.

You enable the Electronic Shutter on the IQ4 in the menu system under **Camera > Electronic Shutter** and ensure that it is set to **On**.

As a new feature on the IQ4, you can now do the wake-up step directly from the IQ4 touch screen. This only requires using the new Multiport to PC-sync cable (part number 50300298). If you prefer to use a two-shot release operation instead, it can still be accomplished, and requires the new Multi Connector to Minijack adapter cable (Part number: 50300306) since the IQ4 now uses a 12-pin multi-connector port.

Please read later in this chapter on how to use these two cables with the IQ4.

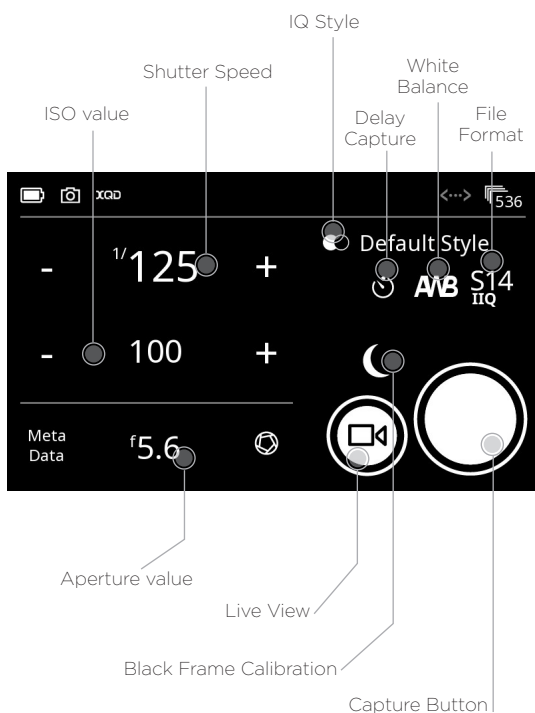

Setting the Exposure

Using the **Camera Controls** to change the exposure settings are straightforward - simply touch the shutter speed or ISO value icons to change them. Please see the Camera Controls chapter for more information.

Note that since the aperture is set on the technical camera lens, you will need to enter the used aperture value in order for it to be written correctly into the metadata of the image.

Be aware that you cannot adjust the Shutter Speed value in Camera Controls when Electronic Shutter (ES) is turned **Off**. This is by design, as the IQ4 will then assume that shutter speed is being controlled by the mechanical shutter on the Tech Camera.

Self Timer Delay

It is possible to specify a delay from when the **Capture** button on the screen is pressed until the image capture begins. Just tap on the **Self Timer Delay** icon and choose the desired value. The delay is then displayed on the Capture button. Once you press the Capture button, a countdown will appear until the image capture begins.

Black Frame Calibration

Prerecorded Black Reference Frame

The new Prerecorded option for black reference frame recording on the IQ4 150MP will provide a faster capture. The option is a parameterized, prerecorded method, thus removing the need for the black reference frame recording that is normally needed after each new image capture.

The option is particularly useful when shooting with the Electronic Shutter with technical cameras where it will lead to a much faster workflow.

Note that since the Prerecorded option is not captured under the currently used camera settings and lighting conditions, it may not provide quite the same level of noise reduction at the pixel level as the traditionally recorded black reference frame. It is only available on IQ4 150MP models, and not the IQ4 100MP Trichromatic.

It is currently not recommended to use the option for shutter speeds longer than 1/10 second.

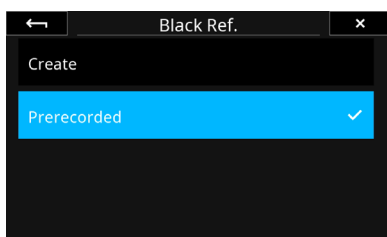

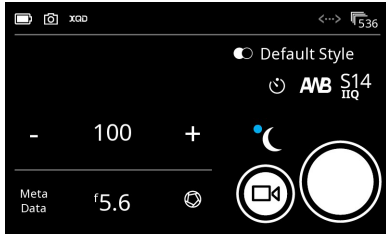

You toggle it on and off by tapping on the **Black Frame Calibration** icon (see the illustration on the top left). If there is no blue dot by the icon, the IQ4 is using **Prerecorded**, while the blue dot indicate the use of a traditional black frame calibration.

You can also enable it in the menu by selecting **File Settings > Black Ref. > Prerecorded**.

If you cannot use the Prerecorded option - this is the case if you are using the IQ4 100MP Trichromatic - you will need to capture a black frame calibration after each image. This cannot be done fully automatically when the IQ4 is mounted on a technical camera, since the IQ4 has no way of determining whether light is hitting the sensor or not. So when a black frame calibration is needed, the IQ4 will prompt you to cover the lens during the black frame calibration capture.



Enable Antiflickering

When using the Electronic Shutter, there are certain shutter speed values that do not work well with light sources flickering at either 50Hz or 60Hz. You can enable this feature by going to the **IQ4 Menu** and selecting **IQ Settings > Antiflickering**. Then select either **50Hz** or **60Hz**.

Be aware that the fastest available shutter speed will be capped when using Electronic Shutter in combination with the Antiflickering feature. If you have selected **50Hz**, the fastest possible shutter speed will be 1/100 second, while **60Hz** sets the limit to 1/125 second.

Please note that Antiflickering will not be in effect if you are using P or Av mode on the XF Camera.

Using Wake-up cables on the IQ4

When using a mechanical shutter on the Technical Camera lens, please ensure that Electronic Shutter (ES) is set to **Off** the IQ4 in the menu system under **Camera > Electronic Shutter**. When operating the IQ4 in ES mode, wake-up cables are not required.



Using the Multiport to PC-sync cable

1. Mount the IQ4 on the Technical Camera.
2. Connect the **Multiport to PC-sync cable** (part number 50300298) from 12-pin multiport on the IQ4 to the PC-sync connector on the Copal shutter, or to the flash connector on the Schneider Kreuznach, Rodenstock or Sinar electronic shutter system.
3. If you are using a flash system, connect it to the flash sync connector on the IQ4.
4. Select the Camera Controls on the IQ4, then press on the Capture button on the IQ4 screen to wake up the back.
5. Trigger the mechanical shutter on the lens, preferably by using a shutter release cable.



Using the Multi Connector to Minijack adapter cable

1. Mount the IQ4 on the Technical Camera.
2. Connect one end of the **Wake up Cable for Phase One one-shot backs** (part number: 50300131) to the flash-sync port on the lens' mechanical shutter and the other end to the new **Multi Connector to Minijack adapter cable** (Part number: 50300306). Then connect the sync cable to the 12-pin multi-connector port on the IQ4.
3. If you are using a flash system, connect it to the flash sync connector on the IQ4.
4. Once you are ready to capture, push the button on the Wake-Up cable to alert the IQ4 to get the sensor ready for the capture.
5. Trigger the mechanical shutter on the lens, preferably by using a shutter release cable.

Note that if the time span between pushing the Wake-Up button and the shutter release is too long, the capture will be abandoned and the IQ4 will show you a warning.

Flash Photography



The XF Camera has a range of powerful flash photography features. First and foremost, the functionality of the Profoto Air system is built directly into the camera, letting you work easily and efficiently with any Profoto Air flash setup.

With the integrated Profoto Air Tool, you can control up to six groups of Profoto lights wirelessly directly from the XF Camera display and fire the different flash groups. The XF Camera also supports TTL and Profoto AirTTL flash metering, making it easy to get accurate exposures under changing lighting conditions when working on location.

You can even trigger a capture remotely with a Profoto Air Remote, or review flash duration, output power and flash sync timing after each capture with the Flash Analysis Tool. You also have the option to trim the flash sync timing directly from the camera to achieve perfectly timed flash results.

All of these powerful flash photography tools are explained in detail in this section.

The XF Camera can also work with a range of other flash solutions in manual mode, and the camera offers flash syncing up to an unprecedented 1/1600th of a second with the majority of Schneider Kreuznach LS (Leaf Shutter) lenses.

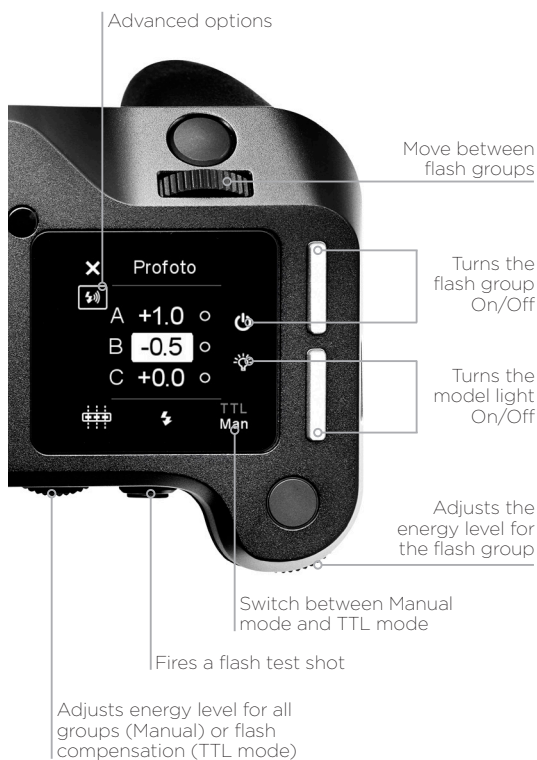

Profoto Remote Tool

The XF Camera System can wirelessly control any Profoto Air-enabled flash system through the Profoto Remote Tool. The tool is designed to work in almost the same way as a Profoto Air Remote unit, in order for you to use it as easily as possible with a Profoto Air system. You get to the Profoto Remote Tool by swiping on the top touch screen.

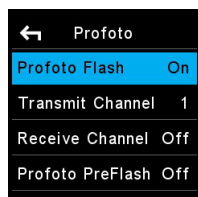

Enabling Profoto Flash

Enabling Profoto Air Sync and Air Remote

Profoto Air Sync and Air Remote is not enabled by default. To set up the wireless syncing and controlling function, access the camera menu and select Capture Setup > Profoto > Profoto Flash > On. The wireless channels for both Transmit and Receive can be selected in the same menu. Select between channels 1 to 8. Channel selection should correspond to the channel selected on the Profoto flash system or Profoto Air Sync transceiver in use. You also have two options to turn Profoto PreFlash On or Off, and set the AirTTL mode.

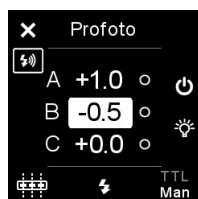

Changing the Energy level with Profoto Remote Tool

Using the Profoto Remote Tool

You select and move through the different Flash Groups A, B and C with the Front Dial, and then change the selected energy level, indicated in stop increments, with the Side Dial. Note that any changes you make to the energy levels with the Profoto Remote Tool are done as incremental values that add or subtract from the current energy levels on the flash generator. So if the energy level on the flash generator is at 6.0 and you dial in a +0.5 value on the Profoto Remote Tool, the energy level on the flash generator will be changed to 6.5. Once the flash has fired, the energy value on the Profoto Remote Tool will be reset to 0.0, but the energy level on the flash generator will stay at 6.5 until changed again. Note that the Profoto Remote Tool cannot be set up to show what the current energy level is on the flash generators. The rear button on the XF Camera is used to test fire the flash system.

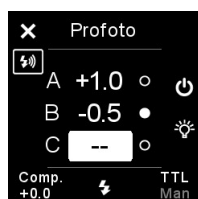

Controlling Flash Group and Model Light

Turning a Flash Group On/Off

The top front button is used to turn the selected Flash Group on and off. If a Group is off, two dashes are shown instead of an energy value. If you keep the top front button pressed for a few seconds, then all Flash Groups will be switched on or off.

Turning the Model Light On/Off

Use the top rear button to turn the Model Light on and off for the selected Flash Group. A white dot will indicate that the Model Light is on. If you keep the top rear button pressed for a few seconds, you can switch the Model Light On or Off for all Flash Groups at the same time.



TTL mode enables the Flash Compensation Value

Changing between Manual mode and TTL mode

You can change between shooting in Manual mode or TTL mode by turning the until you reach the option at the right bottom corner of the Profoto Remote Tool. Then turn the Side Dial to switch.

Note that when Manual mode is selected, the Rear Dial will change the energy level for all Flash Groups at the same time regardless of which group is selected. If TTL mode is selected, the Rear Dial will instead control the Flash Compensation Value.

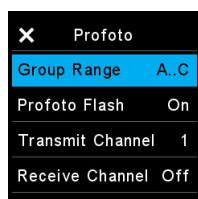

Advanced Settings menu for Profoto Tool

Changing the number of Flash Groups

You are able to control three Flash Groups with the Profoto Remote Tool by default, but you can change this range down to one and up to six Flash Groups. You do this by tapping the Advanced Settings icon which is just below the Close Tool icon in the upper left corner. You then change the Group Range from A..C to A..F with the Side Dial if you want all six Flash Groups enabled. Note that the Advanced Setting menu also lets you change Transit and Receive channels as well as Profoto PreFlash and AirTTL mode.

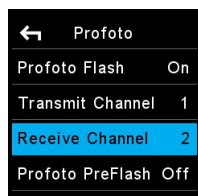

Changing Transmit and Receive channels

Triggering a Capture with the Profoto Remote

You can use a Profoto Remote unit to trigger a capture with the XF Camera remotely as well as firing the flash system during the capture. For this to work correctly, you need set the Transmit Channel and the Receive Channel to two different channels and make sure that the Profoto Remote controller matches the Receive Channel and the Profoto Air flash system matches the Transmit Channel.

To setup the Transmit Channel and the Receive Channel, press the Rear Key and select Capture Setup > Profoto. Then select either the Transmit Channel or the Receive Channel and turn the Side Dial to select the desired channels.

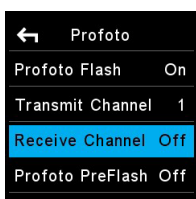

Disabling the Receive Channel



Disabling the Transmit Channel

Note that you can set both the Transmit Channel and the Receive Channel to Off. If you set the Transmit Channel to Off, the XF Camera will not trigger a flash system, and you can use the Profoto Remote as just an external wireless trigger when you do not need a flash. Likewise, you can set the Receive Channel to Off if you do not want to ability to trigger a capture remotely, but still need the XF Camera to trigger the Profoto flash system.

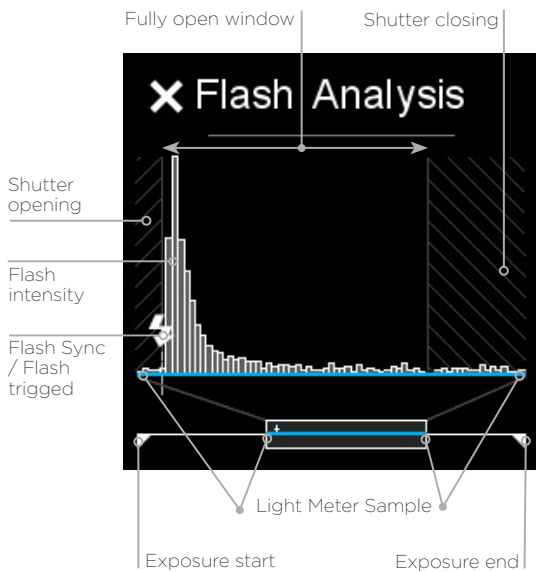

Flash Analysis Tool

The Flash Analysis Tool is used to visualize the flash output power, flash duration and timing within the exposure where a flash is fired. The Flash Analysis tool can be reviewed when accessing the tool from the Icon on the Top Screen or through the swipe menu.

At the bottom of the Flash Analysis Tool, there is an exposure line that represents the time in which the sensor is exposed to light. The two white triangles are indicators for the start and the end of the exposure.

On top of the exposure line there is a blue rectangle overlay, called the Light Meter Sample. This is a magnified part of the full exposure which visualizes the time range in which the flash has been fired.

Within the magnified part, there are one or two striped segments. These represent the time in which the shutter is partially or fully closed. The black segment of the graph in the middle represents the time in which the sensor is fully exposed to light.

In the lower left corner of the graph the flash sync icon indicates when the flash is fired. Once a flash is fired, you will see a series of vertical white bars that indicate the strength, duration and fall off the flash light.

Note that time interval of the Light Meter Sample is always equal to approximately 7 ms. — 1/125th of a second — and start right after the flash is triggered. So, when a flash is fired within this time interval, you will see the beginning of the flash output coincides with the flash sync icon.

Rear Curtain sync and Trim

Note that you have the option of choosing between front and rear curtain sync for your flash system from the XF Camera. This is done by accessing the camera menu and selecting Capture Setup > Flash Curtain > Front/Rear.

In addition, you can trim the flash sync timing directly from the XF Camera to achieve perfect results. If you are using rear flash sync, you can trim the sync timing to fit your specific photographic needs, and this feature is particularly useful in combination with the Flash Analysis Tool.

To find this setting, access the XF Camera menu and select Capture Setup > Rear Curtain Trim. By default, this trim is set to a value of -5. A value of 0, when using rear curtain sync, indicates that the flash fires at the exact moment the shutter closes. Moving it to a positive value will fire the flash after the shutter closes.

This is applicable only when using Focal Plane Shutter as the shutter in this mode takes some time to close. Moving the value to a negative value offsets the flash sync to a point closer to the start of the exposure.

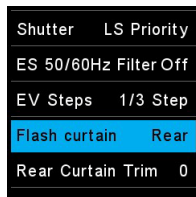

Flash Curtain Rear

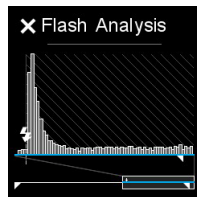

Flash Analysis Tool with Curtain set to Rear

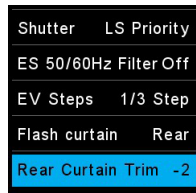

Rear Curtain Trim

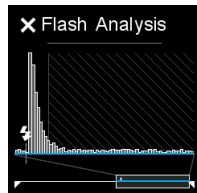

Flash Analysis Tool with Rear Curtain Trim

Shutter Mechanisms and Flash Synchronization range

There is a big difference in the way that the Focal Plane Shutter, the Leaf Shutter and the Electronic Shutter works when you shooting with a flash system. Because of this, it is valuable to know how the different shutters work to fully take advantage of the Flash Analysis Tool.

AF Drive	Single
AF Priority	Focus
Assist Light	Off
Shutter	FPS Only
ES 50/60Hz Filter	Off

Focal Plane Shutter (FPS Only)

Focal Plane Shutter (FPS)

The focal plane shutter works by having two curtains moving vertically in front of the sensor to control the exposure time. First, the front curtain opens so the light can start to reach the sensor, and after the appropriate delay, the rear curtain follows and closes the exposure. It takes several milliseconds for the curtains to move from open to closed. This is important to know if you are using a fast shutter speed, because then one or both curtains will cover a part of the sensor, and the fired flash will only light up a row of all the pixels. Because of this, the flash sync speed with the focal plane shutter cannot be faster than 1/125 second. Note that the Flash Analysis Tool will show a hatched pattern to indicate when the shutter is not fully open.

AF Drive	Single
AF Priority	Focus
Assist Light	Off
Shutter	LS Priority
ES 50/60Hz Filter	Off

Leaf Shutter (LS Priority)

Leaf Shutter (LS)

The leaf shutter built into the Schneider Kreuznach Leaf Shutter lenses works in a different way. Instead of curtains moving vertically, the shutter consists of a series of blades, that opens and closes — not unlike a lens aperture — to control the exposure. In effect, they form a hole that gradually becomes smaller until it is fully closed. It works a lot faster than the focal plane shutter and has the advantage that all pixels gradually get less and less light until the exposure ends. Because of this, the flash sync speed with a leaf shutter can be as fast as 1/1600 seconds. Note that when the XF Camera is using the leaf shutter as the second curtain, it automatically uses an electronic first curtain. The electronic first curtain works almost instant, so when you are inspecting the Flash Analysis Tool, you will note that the shutter is almost fully open during the entire exposure time.

AF Drive	Single
AF Priority	Focus
Assist Light	Off
Shutter	ES only
ES 50/60Hz Filter	Off

Electronic Shutter (ES Only)

Electronic Shutter (ES)

When you use the Electronic Shutter feature on the IQ3 100MP, both the first and second curtains are fully electronically and controlled by the sensor. No mechanical shutter is used. Since the sensor cannot open and close all the pixels simultaneously, it instead uses a rolling shutter mechanism where it reads lines of pixels slowly across the sensor. It can take more than a second to read out the entire sensor, so the shutter time must be long in order for the flash light to hit all pixels on the sensor. As a consequence, the electronic shutter will only support flash sync of around 1.6 seconds, but note that it will work perfectly when using continuous light for copy stand photography.

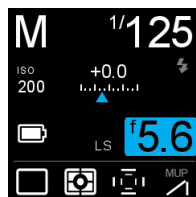

Flash Readiness Icon

Synchronization readiness is indicated on the top screen with a small flash icon located beneath the shutter speed setting. If a flash icon is not visible, the shutter speed setting is outside range of the attached lens or manually selected shutter.

Wired Flash

Wired manual flash is possible through the flash sync port on the XF Prism Viewfinder or IQ Digital Back, with appropriate cable. Manual flash is also possible through the hot shoe, located on top of the prism viewfinder. Slave units and wireless transmitters can also be connected. Please refer to their respective user manuals for more details.

Note Phase One A/S cannot accept responsibility for accidents or damage occurring as a result of using third-party devices in conjunction with Phase One equipment.

XF Camera System Lenses

Focal Plane and Leaf Shutter Lenses

The Phase One XF IQ4 Camera System offers a dual shutter option for the utmost in exposure versatility with flash and ambient light.

Phase One FPS (Focal Plane Shutter) lenses

The XF Camera Body has a built in focal plane shutter (FPS) for use with Phase One lenses and offers a range of Shutter Speeds from 1/4000th second to 1 hour, however flash sync is limited to a maximum of 1/125th of a second Shutter Speed.

Schneider Kreuznach LS (Leaf Shutter) lenses

Schneider Kreuznach lenses have a built-in leaf shutter (LS). When used in combination with the Phase One XF Camera Body and IQ4, the leaf shutters have the capability to synchronize with flash systems up to an unprecedented 1/1600th of a second Shutter Speed.

AF Drive	Single
AF Priority	Focus
Assist Light	Off
Shutter	LS Priority
ES 50/60Hz Filter	Off

If using LS lenses, the XF Camera Body will indicate if LS or FPS is active on the top screen. The shutter preference can be set using the camera menu from the top screen, or from the XF menu on the IQ4. Select Capture Setup > Shutter > LS Priority / FPS Only.

You will also have the option to use the Electronic Shutter (ES) by choosing 'ES Only'. In that case, the XF Camera Body will display ES on the top screen.

Advantages of FPS (Focal Plane Shutter)

One notable advantage of FPS is ability to shoot up to 1/4000th of a second. This overcomes the use of ND filters that results in reduced viewfinder brightness and AF performance. Another benefit is the shutter response time, which is almost twice as fast as a leaf shutter. This means that if you are photographing within the FPS flash sync speed range (using flash or not), there is a shorter time lag between pressing the shutter button and the focal plane shutter being released.

AF Drive	Single
AF Priority	Focus
Assist Light	Off
Shutter	FPS Only
ES 50/60Hz Filter	Off

Shutter preference

Advantages of LS (Leaf Shutter)

If you want to synchronize flash at a Shutter Speed faster than 1/125th of a second, for example to freeze motion or to work with wider Apertures for selective focus techniques when using balanced fill flash, the Schneider Kreuznach LS lens option overcomes the slow flash sync limitations of focal plane shutters. Another advantage is less vibration during capture due to the lower inertia of the lighter weight shutter blades. The issue of vibration, however, is addressed even on non-LS lenses with the Low Vibration mode of the XF Camera Body.

Capture One Pro



The XF IQ4 Camera System is bundled with Capture One Pro. You will need version 11.2.x or later to work with the IQ4.

Installing on Mac

Capture One 12 software includes an easy-to-use installer that will install all the software necessary to run the application on a Mac running macOS 10.12.6, macOS 10.13.6 or macOS 10.14.1.

1. Download the latest version of Capture One Pro from www.phaseone.com/download.
2. Navigate to the downloaded Capture One Disk Image and double-click on it.
3. Drag the Capture One icon to the Applications folder.
4. Open Capture One from your Applications folder.

NOTE:

On Windows, Capture One will initiate installation of Microsoft® .NET Framework, if it's not already installed on your computer.

Installing on Windows

Capture One includes an easy-to-use installer that will install all the software you need to run the application on a Windows based computer.

1. Download the latest version of Capture One Pro from www.phaseone.com/download.
2. Run the executable software install file.
3. Read and accept the license agreement presented.
4. Follow the on-screen instructions to complete the installation.

System requirements

Capture One may run on other and older equipment than those listed below, but to ensure the best possible results we recommend that your computer, at the minimum, conforms to the following specifications:

Microsoft® Windows® minimum requirements

- Intel or AMD CPU with 2 cores
- 8 GB of RAM
- 10 GB of free hard disk space
- Calibrated color monitor with 1280 x 800, 24-bit resolution at 96 dpi screen ruling
- Windows 7® SP1 64-bit, Windows 8.1® 64-bit, Windows 10® 64-bit*
- Microsoft® .NET Framework version 4.7 (will be installed if not present)

*Support for Capture One 12 on Windows 10 is supported for builds supporting .NET 4.7 - This is currently from Windows 10 Anniversary Update (build 1607) through to October 2018 Update (build 1809).

Apple® Macintosh® minimum requirements

- CPU with 2 cores
- 8 GB of RAM
- 10 GB of free hard disk space
- Calibrated color monitor with 1280 x 800, 24-bit resolution at 96 dpi
- macOS 10.12.6, macOS 10.13.6 macOS 10.14*

*Support for macOS 10.14 is supported for builds up to 10.14.4

Recommended system requirements

The above hardware specifications are to be considered as minimum requirements. If you work with high-resolution camera systems or simply want to optimize the performance, please follow the recommendations below:

- CPU with four cores or more, e.g. Intel® Core™ i7 or better
- 16 GB of RAM or more
- Leave plenty of hard disk space free for your images
- Solid State Disk (SSD)
- A fast graphics card from NVIDIA or AMD with 4 GB VRAM or more.

Note: Due to the significant additional calculation overhead, systems using 4k/5k monitors will require additional resources in addition to the above recommended spec (both in GPU and CPU power). For a Professional experience we recommend at least doubling the specification above for these configurations.

Activating Capture One Pro (Mac / Windows)

An Internet connection is required to activate and update Capture One Pro.

1. Launch Capture One and select Pro, then Activate from the respective product dialog boxes.
2. Enter the 16-character license code key provided on the supplied Capture One card and add your personal details to create a Profile in the required fields. (The Capture One Pro license code card is available inside the Capture One packaging).
3. Once you have entered the information, press the Activate... button and Phase One's server will validate the software.
4. Capture One should now be activated and ready for use.

NOTE:

A Phase One Profile is required for activation and future updates and upgrades. If you do not already have a Phase One Profile, please enter an email address and password to create a new Profile ID.

Updates to minor version releases of Capture One are free. For example, updating from Capture One Pro 11.0 to 11.2 is free. Upgrades to major version releases, for example, from Capture One Pro 11 to Capture One Pro 12, are paid for.

A Capture One Pro 12 key will activate earlier versions. For example if you prefer to use Capture Pro 11, the license code may be used for that instead. Please note this does not apply to subscriptions.

Capture One Pro DB supports Phase One backs only, but it does not require an activation key or a license. This means that you can always use the latest version of Capture One by selecting the Pro DB version during install and use that for free.

If you need support for other camera makes as well as Phase One, please use the paid Capture One Pro version.

Troubleshooting

If you are experiencing problems activating the software, follow the instructions provided in the application, read the Capture One help manual online, or visit our website for inspiration and troubleshooting: <http://www.phaseone.com/support>



Capture One Tethered Use



NOTES:

A battery must be installed in the IQ4 for it to function properly, regardless of whether it is exhausted or not. If it is flat and the data-bus is powered, the battery will start to be charged.

Shooting Tethered

As a professional tool for working photographers, the IQ4 can be tethered to a Mac or PC running Capture One Pro raw workflow solution. In addition to being able to select and control a wide range of camera functions including exposure, focus confirmation and Live View, images can be saved to the computer's hard disk as well as the XQD and SD memory cards, as a back-up.

Connecting to a Computer

The IQ4 can be tethered to a computer using either Gigabit Ethernet or USB-C cables or WiFi. Please see the previous chapter Tethering Connections for more information.

Online Support

For more information on shooting tethered with Capture One please consult the online user guide available in the Capture One Help menu or go direct to <https://help.phaseone.com/en/CO12/Tethered-Capture.aspx>

Charge when tethered

The IQ4 has an integrated battery charger to ensure that the batteries are charged when shooting tethered to a computer.

Import Images into Capture One Pro

The IQ4 captures proprietary RAW files which require processing in Capture One or similar software to output these files as TIFFs. The IQ4 can also save captured images as JPEG versions, but you will need to process the RAW files to JPEG in Capture One if you want full resolution JPEGs.

Import Images

Inserting a memory card into a card reader attached to a computer will automatically display the Import Images dialog window, when Capture One Pro is running.

Manual Import of images

1. Go to File and select "Import Images..." The dialog box will open to browse files.
2. Navigate to the "Import From" folder, card or disk in the Locations tool.
3. Select Capture folder (import location) and type in the job name and Metadata (copyright, caption) if desired.
4. If you want to select a naming format for the imported files, press "Format" in the Naming tool.
5. Select all or specific images to import.
6. Press "Import" or "Import All". You can continue working while images are imported in the background.

Capture One User Guide

Available in the Capture One Help menu or go direct to:
<http://help.phaseone.com>

Capture Pilot



When shooting tethered to Capture One, the IQ4 can be remotely controlled by the Capture Pilot app from Phase One. A direct wireless connection between the IQ4 and the Capture Pilot app is not supported on the current firmware. You will need to run Capture One as a connection hub between the IQ4 and the app.

Capture Pilot enables the user to remotely control the camera's exposure settings and trigger the shutter on the XF IQ4 Camera System. In addition, Capture Pilot allows browsing and geotagging of images, and even supports remote live view. Capture Pilot is available on Apple iOS devices like iPhone, iPad and iPod touch.

The free to download app can also be a useful solution for clients wishing to view images away from computer screen, either in the studio or on location.

Note raw files are not transmitted to, or stored on, the iOS device. The original files remain on the camera's memory card and/or the tethered computer's hard disk, depending on the setup.

Download the free Capture Pilot app

Please download the free Phase One Capture Pilot app from the Apple App Store and install it on your iOS device.

Version 1.12 requires iOS 10 or later.

Capture Remote, the remote camera operation function of Capture Pilot, is free and automatically enabled upon a connection with the IQ4 via Capture One.

For control of other makes of DSLRs, an in-app purchase of Capture Remote is required. Please check compatibility, before making a purchase. Note for other makes, remote control applies to cameras tethered to a computer running Capture One Pro.



Download Capture Pilot from App Store

Connecting an iPad or iPhone to Capture One

Ensure that there is a tethering connection between the IQ4 and the computer running Capture One.

In Capture One, open the **Capture Pilot** tool, type in a **Server Name** and from the **Folder** drop-down menu select which folder you want to share the captured images from. This will typically be the folder location where you are capturing the images to.

It is possible to type in the password if you are on a large, shared network but it is not required. Then choose **Mobile Device** (or Mobile and Web) from the **Publish To** drop-down menu and finally click on **Start Image Server**.

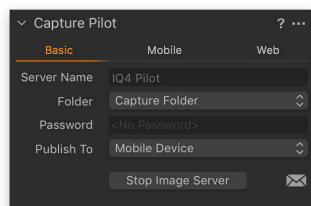

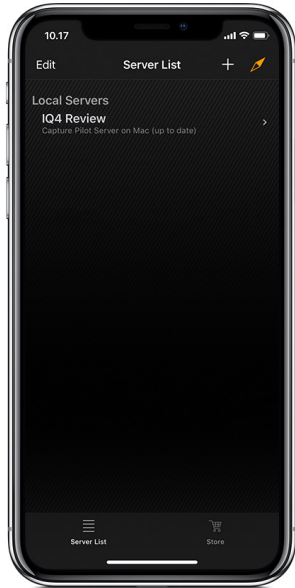

Using the Capture Pilot app

Open the Capture Pilot app on the iPad or iPhone and select the name Server from the Server List.

Tap on an image to view it full screen. You control the app by tapping on the icons at the bottom. The Camera icon opens the Camera window where you can adjust basic settings and capture the next image.

The next icon opens a histogram that you can select and move to another location on the screen. The Star icon opens a little row that let you set the color tag and star rating of the current image. Finally, you can set the white balance by tapping on the picker icon. Once activated, you tap on a specific area on the image to set the white balance from that part. On the right side, you can move through the captured images.

Using Capture Pilot



Adjust exposure settings

Capture

Toggle Camera Controls off



Enable Camera Controls

Show Histogram

Move through captured images

Rate and Color Tag images

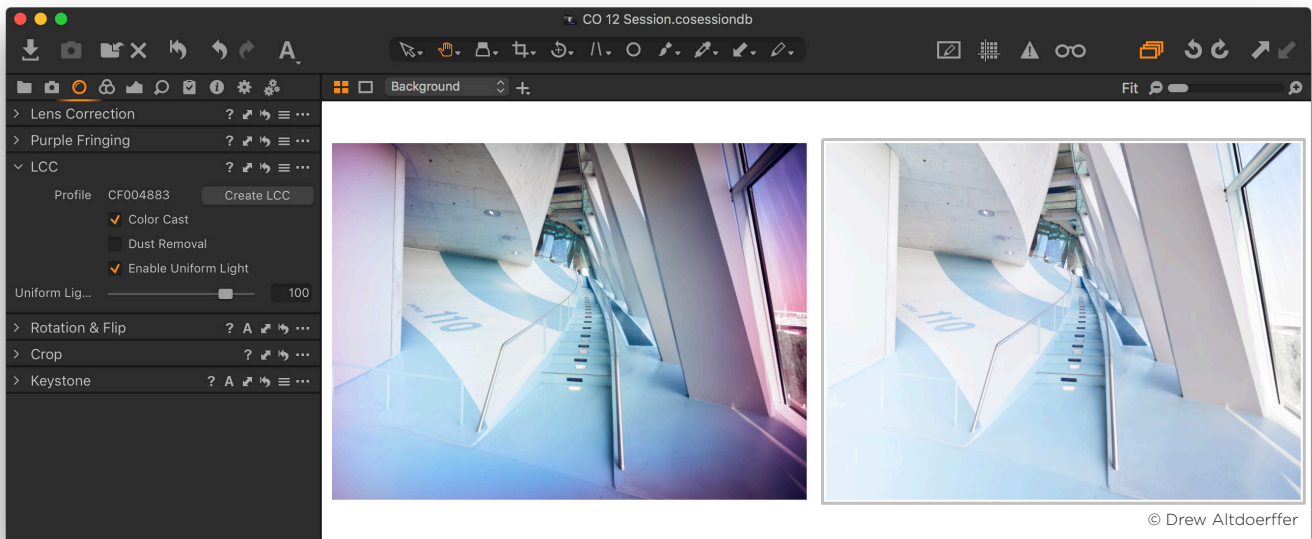

Lens Cast Calibration

Some lenses on technical camera systems have their rear element positioned very close to the sensor surface of the Digital Back, thereby projecting the light in a very steep angle, which can result in color cast and luminance uniformity issues effecting image quality. Tilt and shift movements can in addition introduce, or amplify, the problem. The LCC (Lens Cast Calibration) tool in Capture One Pro is designed to correct for the color and luminance uniformity issues by analyzing and applying a correction made from an LCC capture.

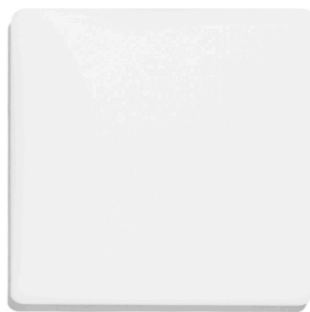

Phase One LCC Plate

To use the LCC tool, you will need to make an LCC capture. An LCC capture is a photograph of an evenly-lit semi-transparent card, used as a reference image within Capture One's LCC tool. The Phase One LCC Plate (part number 70722) is made specifically for the purpose.

It is important to be aware that a lens cast is specific to the relationship between the lens and the sensor planes. If there are any changes to the angle or distance between these two planes, like adding a shift, the light rays will hit the sensor from new angles, and a new LCC reference image should be created. The same is true if you adjust the aperture as this will change the shape of the light.

A new LCC reference image needs to be created if you change any of the following parameters:

- Use a new sensor / lens combination
- Change the Focal Length
- Change the Aperture
- Adjust the Shift (X and Y)
- Adjust the Tilt or the Swing
- A change in the direction of the light in the scene
- Change the focus distance (less important, see below)

Changing the focus distance should only have a minimal impact. However, there might be a slight difference if you capture the LCC reference image at infinity focus while shooting the regular images at a close focus distance, or vice versa. The focus distance effect on the LCC calibration image will also depend on the focal length, so a 90mm lens will show more variation than a 23mm lens. If you want to play it safe, then capture an LCC reference image at the working focus distance.

Changes to the shutter speed or ISO value will not have any notable impact on the creation of an LCC.

It is not an absolute necessity to capture the LCC reference image under the same lighting conditions as the real images, although it is recommended for best possible image quality. It is, however, important that the LCC plate is evenly lit, and in order to accommodate for the loss of light from the semi-transparent card, it is suggested to decrease your shutter speed by two stops.

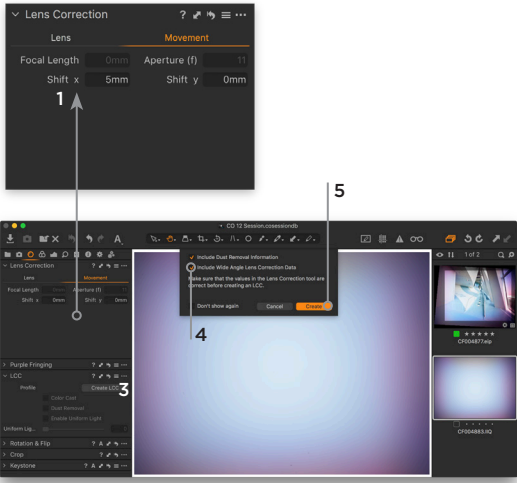

Creating an LCC profile in Capture One

1. Once you have made an LCC reference capture, select the RAW file in Capture One. Go to the **Lens Correction** tool and select the correct lens from the **Profile** menu. Then select the **Movement** tab. Make sure that the metadata **Focal Length**, **Aperture (f)**, **Shift x**, and **Shift y** is correct. Otherwise, enter the correct values.
2. For future reference, it is always a good idea to rename the LCC file, so you can easily recognize it later by naming it for example "35mm_+10shift_f11".
3. Go to the **LCC** tool and click on **Create LCC**.
4. Enable the **Include Wide Angle Lens Correction Data** option if you are using a wide-angle lens and some degree of movements with a tilt or shift lens. This option initiates a special LCC process that is designed to correct for banding at the extreme edge of the image circle on higher resolution digital backs. You can also enable the **Include Dust Removal Information** option to create a map which automatically removes dust. Note that this will increase processing time and negates future use of the LCC.
5. Click **Create** in the dialog box. Capture One now analyzes the reference image and creates an Lens Cast Correction.

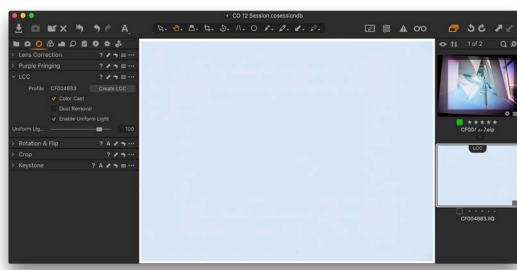

6. When completed, the reference image used will be labeled LCC in the Browser. The created Lens Cast Correction will be applied automatically to the reference shot, letting you check immediately whether it was successful. It should show an evenly exposed light grey image without a color cast, vignetting or dust spots (if you have selected that option). It may be necessary to adjust the white balance of the image to evaluate the proper application of the LCC.

Workflow tip: If you have multiple LCC reference shots to calibrate, you can save time by selecting them all and click on Create, then Capture One Pro will work through them one by one.

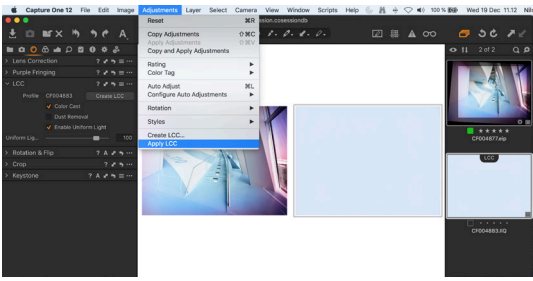

Applying an LCC profile

You apply an LCC profile to an image by first selecting the LCC reference shot and then the image in the Browser, next go to the **Adjustments** menu and select **Apply LCC**. You can also right-click on the image in the Browser and select **Apply LCC**. Notice how the used LCC profile file name is shown by **Profile**.

Workflow tip: You can select multiple images and apply one LCC profile to them all by using the same process.

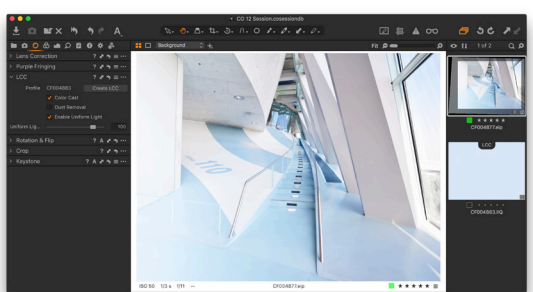

Adjusting the LCC profile effect

Once an LCC profile has been applied, you can fine-tune its effect on the image with the LCC tool. You can turn the color cast correction on and off with the **Color Cast** option as well as the **Dust Removal** if any dust was found on the reference image. You can also control the correction of **Light Falloff** with **Enable Uniform Light** and the **Uniform Light** slider. You might, for example, want to dial the correction down a bit to 75% with the slider in order to retain some of the light falloff for artistic reasons.

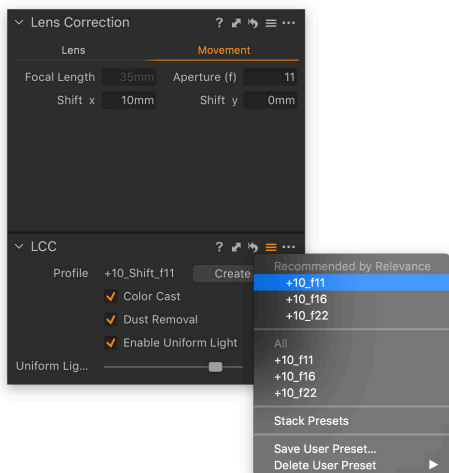

Using Presets to speed up the LCC workflow

Saving a created LCC profile as a Preset is a great way to be able to quickly apply a Lens Cast Calibration to several images. As a new feature in Capture One 11.1, the LCC tool will look at metadata like focal length, aperture and shift x and shift y in the **Movement** tab and show a list of recommended Presets based on those that match the target image the best.

You can leverage this functionality to build a library of LCC Presets, ready to use if you didn't have the opportunity or time to shoot LCC reference images on location.

For best possible image quality, we recommended that you shoot the LCC reference image in the same lighting conditions as the target images, but the LCC Presets is a great solution when a fast workflow is important.

As mentioned in the start of this chapter, you will need to shoot a LCC reference image for each combination of Focal Length, Aperture, Shift (X and Y), and Tilt or Swing. The shooting matrix for a full LCC library can thus be rather wide-ranging when all the Shift values are to be included, for example, so consider concentrating on the most used combinations.

Saving a LCC Preset is also by far the most convenient way of sharing LCC profile between different Sessions and Catalogs.

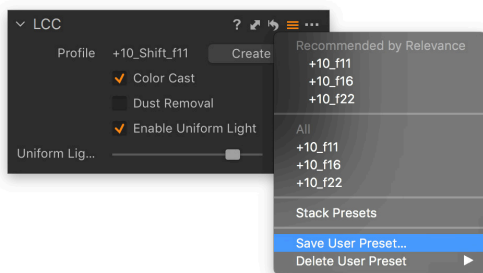

Saving the LCC profile as a Preset

Once you have created a LCC profile, select the LCC file, click on the **Preset** icon and choose **Save as Preset...** You will now get the options to save the LCC **Profile** as well as the **Color Cast**, and **Uniform Light** corrections as part of the LCC Preset. Make sure to deselect **Dust Removal** as dust on the lens will change over time and should only be used when the LCC Profile is created on location.

Be aware that the Focal Length, Aperture, Shift x, and Shift y metadata in the **Movement** tab is saved during the creation of the LCC profile itself, so anything entered now will not be a part of the Preset. When ready, click **Save**.

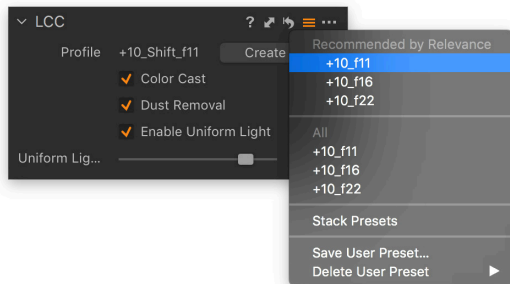

Applying the LCC profile as a Preset

As a new feature in Capture One 11.1, the LCC Preset manager will show a list of the recommended Presets for the selected image based on what metadata that matches the best. Click on the **Preset** icon and select a LCC preset from the **Recommended by Relevance** list. The best match will be ranked at the top of the list. The list is sorted based on the Focal Length, Aperture, Shift x, and Shift y metadata in the **Movement** tab as well as the Lens Profile, so remember to enter these correctly on the target image for the **Recommended by Relevance** list to work correctly.

If a Preset is greyed out and can't be selected, the sensor or serial number from the camera/digital back is different from the one used to generate the LCC profile.

Note that it is also possible to apply the LCC Preset during tethered shooting from the **Next Capture Adjustments** tool under the **Styles** drop-down menu as well as during import from the **Import Images** dialog box under **Adjustments** and **Styles**.

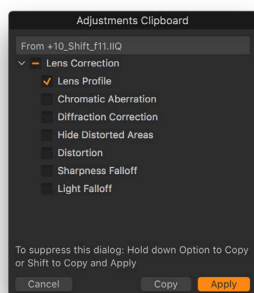

Copying and reusing lens metadata

Since the LCC Preset manager looks at the metadata from the **Movement** tab (Focal Length, Aperture, Shift x, and Shift y values) in order to recommend the most suitable preset, the information here should be entered correctly for all images. This metadata is easy to copy from one image to several others.

First, select the image with the correct metadata entered in the **Movement** tab. Then hold down Shift and select the other images. Go to the **Lens Correction** tool and click on the copy adjustment icon, then select **Lens Profile**, and click **Apply**. The metadata from the Movement tab is now copied to the other images together with the selected lens from the **Profile** drop-down menu.

XF Custom Presets and IQ4 System Backup

XF Camera Body Custom Presets

Custom Presets

Three Custom Presets can be set on the XF Camera Body. This feature allows you to save and reuse combinations of settings you have made to the system to suit your preferences and workflow. Custom Presets also minimize inadvertent use of settings, where the same camera may be adopted for very different assignments or commissions throughout the day. All the current settings can be saved in a Custom Preset.

Save Custom Presets

Set up the camera with the various settings required, then press the Rear Key on the XF top screen and from the menu select Save Setup > Custom 1 > Save Setup > Yes / No. Two further groups of settings can be stored (to Custom 2 and Custom 3).

If you change a setting while using the camera in one of the Custom modes and want that set updated, simply access the camera menu and select Save Setup, remembering to save it to the relevant Custom set.

Changing between Custom Presets

Custom presets are intended to provide a rapid change between groups of settings and features. Press the Rear Key on the XF top screen and from the menu select Load Setup > Custom 1, 2 or 3.> Load Custom Settings > Yes / No. Selecting Yes instantly enables the group of settings. Settings may be continued to be changed afterwards as normal, and to return to the initial group of settings, simply repeat the procedure described above.

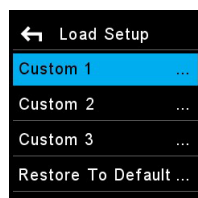

Custom Settings

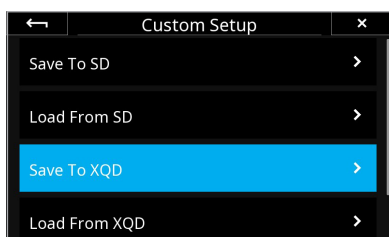

Save Custom Setup to XQD card

Save Custom Setup to Memory Card

In addition to saving custom setups in the XF Camera, you can also save them to the XQD or SD card on the IQ4 as a backup file. This is done by selecting **IQ4 Menu > XF Menu > Custom Setup > Save To XQD** or **Save To SD**. Then choose the Custom Setup you want to save, and press the check mark to accept. The backup file is saved at the root of the XQD or SD card and called XFSYSTEM.set, in case you want to copy it to your computer.



Choose the Custom Setup to replace from the XQD card

Load Custom Setup from XQD Card

Once you have saved a Custom Setup to the XQD or SD card, you can load it back into the XF Camera. This is done by selecting **IQ4 Menu > XF Menu > Custom Setup > Load From XQD** or **Load From SD**. First, choose the current Custom Setup on the XF Camera that you want to load. Next, choose which of the saved Custom Setups on the XQD card you wish to replace it with. Select the one you want, then press the check mark to load it.



Using the touch keyboard to rename the Custom Setup

Rename Custom Setup

In order to better recognize each of your Custom Setups, you can rename them to something more descriptive, like 'Landscape' or 'Studio'. This is done from the IQ4 touch screen with the built-in keyboard by selecting **IQ4 Menu > XF Menu > Custom Setup > Rename**. Then choose the Custom Setup you want to rename, and enter the name on the touch keyboard. Once you are done, press the green check mark to accept the change.

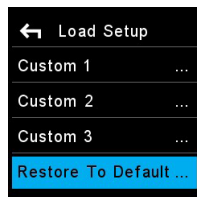

Restore the Custom Presets to Default

Restore to Default

To return the camera to the default settings, access the camera menu and select Load Setup > Restore To Default...

Note the group of settings registered with the Custom Presets will be not be cleared using this option.

Save and Load System Setup

You can easily make a backup of the entire System Setup to the memory card. This backup will include all of your settings on the XF Camera, your Custom Setups, as well as all of the settings on the IQ4.

The feature makes it easy to quickly load your preferred settings if you frequently share the XF IQ4 Camera System with other photographers. It is also a convenient way to quickly be able to reuse all of your settings if you often rent an XF IQ4 Camera System.

The backup file is called XFSYSTEM.set and is stored at the root of the memory card. From there, it can be copied to your computer for further backup or sharing. Note that the file will get erased if you format the memory card.

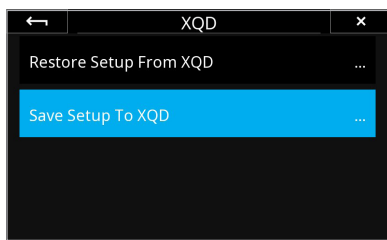

System Setup has been saved to the XQD card

Save System Setup to XQD or SD Card

The backup of the System Setup is done from the IQ4. Select **IQ4 Menu > System Settings > Save/Restore System Setup**, then select either **XQD** or **SD**, and finally **Save Setup to XQD** (or **SD**) and press the check mark to accept. The system will now confirm that the System Setup of both the IQ4 and XF Camera has been saved to the XQD (or SD) card. If the XF Camera Body is not attached to the back, only the IQ4 settings will be stored.

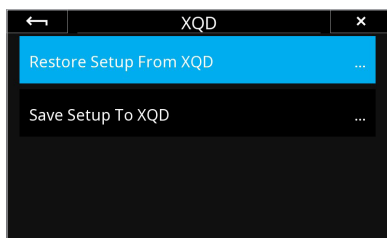

Loading the System Setup from a XQD card

Load System Setup from XQD or Sd Card

To load your saved System Setup, select **IQ4 Menu > System Settings > Save/Restore System Setup**, then select either **XQD** or **SD**, and finally **Restore Setup From XQD** (or **SD**) and press the check mark to accept. You will need to turn the system off and back on before all the changes are applied. If there is no valid backup file present on the XQD card, you will get a warning.

NOTE:

Settings like Focus Trim and HyperFocal focus values are stored as part of the System Setup backup and will be applied if you save and load the System Setup on the same XF Camera Body. However, they will not be applied if you load the System Setup onto a different XF Camera. The reason for this is that Focus Trim and HyperFocal focus values have to be setup individually for each camera system in order to work correctly.



You can choose to keep certain settings during a Restore to Default

Restore to Default

You can easily restore all of the settings to the default values. This is done from the IQ4 Menu, selecting **System Settings > Restore to Default**. As a convenient feature, you have the option to choose whether Custom White Balance values and Network Setup should be reset or kept during the restore. Select only those you want to reset to default values, and press the check mark to accept. This feature makes sure that you do not have to reenter some common settings each time you need to restore the system to default settings.

System Maintenance

Keeping your XF Camera clean

Your XF Camera System generally needs very little maintenance. However, as this is a professional tool it should be treated with proper care and caution. Always perform test shots before a photographic session if the camera, for any reason, has not been used for a long period of time.

Note: If the camera is suddenly taken from a cold to a warm place, condensation may form on the camera and internal parts. In this case, do not use the camera. Instead remove the lens, the memory cards and batteries from both the XF Camera and the IQ4. Then wait until the condensation has evaporated before using the camera again.

XF Camera Body

Keep the electronic contacts and back mount of the XF Camera Body clean and free of dust with a dry microfiber cloth, but do not re-use the cloth on the lens' surface. If the camera has been exposed to salty air, wipe it clean with a well-wrung wet cloth.

To clean the screen on the IQ4 or the Top Touch Screen on the XF Camera, wipe it using a microfiber cleaning or soft dampened cloth. This will remove dust, dirt and fingerprints from the screen without scratching or streaking.



WARNING: Do not use any solvents or liquid-based cleaners as these substances may damage the lcd screen coating. Never touch the electronic contacts with your fingers as this can lead to corroding of the contacts and camera system malfunction.

Lenses

If there is any dust on the surface of optics, first try to remove it with a rocket air blower. Never use compressed air unless the product is made specifically for photographic equipment, since the propellant can leave residue on the glass surface that can be very difficult to remove.

If there are smudges on the lens surface, use the dry lens cloth that was supplied with the lens. Make sure to remove as much debris as possible with an air blower first, so you do not end up grinding the debris into the glass. It might be necessary to moisten the lens cloth with a fluid lens cleaner. Then use a circular motion to gently remove smudges from the lens surface, working from the center outward. Dust and smudges on the rear element of the lens will have the most impact on image quality so make sure to clean this part regularly.

Please note the lens is not waterproof. If it becomes wet, it should immediately be dried with a cloth. If the lens is exposed to salt spray, moisten the cloth and carefully clean the lens.

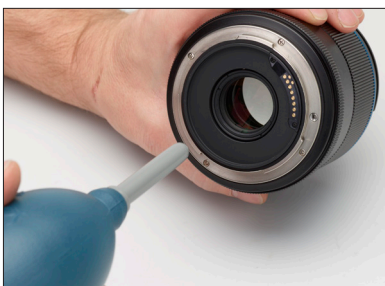

WARNING: Never touch the optics of the lens with your fingers. Do not use chemicals on a lens tissue or cleaning cloth that are not specifically made for lens cleaning. Facial tissue is not recommended, as some brands are abrasive and others contain oils and lotions that can streak your lenses. Do not touch the electronic contacts with your fingers.



Dust or dirt on the viewfinder will never impact the image quality, but can be quite distracting during a shooting session. Detach the viewfinder and first try to remove the dust with a rocket air blower. Then, if there is still some debris or smudges, simply moisten a lens cloth to wipe the smudges away. It is easier to clean the diopter if you remove the rubber eyepiece first by grasping the sides and pushing it upwards. Remember to clean the large glass plate at the bottom of the viewfinder too.

Note: Never use chemicals as they might leave streaks on the viewfinder.



Focusing Screen

The focusing screen is a very delicate part that can easily be damaged. If you observe any dust or dirt on the top outside of the focusing screen, you can gently try to remove it with a rocket air blower. If the dirt seems stuck, do not attempt to use force to remove it, but instead contact your reseller or a service center for guidance on how to get it cleaned. If you observe dust or dirt on the inside of the focusing screen, you should also contact your reseller for guidance.

WARNING: Never use compressed air to clean the focusing screen unless the product is made specifically for photographic equipment and do not touch the screen with any tools or your fingers. Scratches to the focusing screen is permanent and cannot be removed.

Cleaning the Sensor on IQ Digital Back

The Phase One IQ Digital Back should always have the protective sensor cover fitted when not attached to a camera. Dust may accumulate on the IR filter of the sensor, which will degrade the image quality if not removed. When cleaning the sensor, please use the Phase One Sensor Cleaning Kit that is supplied with the IQ Digital Back.



Instructions for sensor cleaning:

1. First try to remove any dust or debris with a rocket air blower. This will ensure that no hard particles like sand can scratch the IR filter during the following steps.

WARNING: Never use compressed air unless the product is made specifically for photographic equipment, since the propellant can leave residue on the surface that can be extremely difficult to remove.



2. Locate the small scraper in the supplied Sensor Cleaning Kit and use either the wide (42 mm) or normal (38 mm) end that matches the width of your sensor. Ensure that no dust or loose material is present on the edge of the scraper.

3. Select a cloth from the Sensor Cleaning Kit and fold it over the scraper so that you have two layers of cloth.



4. Apply 2-3 drops of Eclipse® cleaning fluid from the Sensor Cleaning Kit to the edge of the folded cloth.



5. In one motion, swipe the surface of the sensor from one end to another. Do not swipe a second time in the opposite direction.

6. Inspect if the sensor is clean by holding it into the light. If necessary, move the cloth layer one cm on the scraper and repeat the process. Never swipe two times with the same area of the cloth as the removed dirt could risk being reapplied to the sensor.

For quick sensor cleaning during work in the field you can use an air blower or the supplied e-wipe® wet tissues. These can be used with same procedure as outline above, just skip adding the Eclipse® cleaning fluid.

Note: The IR filter (Infrared Reduction Filter) is permanently mounted on top of the sensor. The filter may not be removed for several reasons:

1. Focus accuracy is dependent on the presence of the IR filter.
2. It is only possible to remount the filter without dust degrading the sensor if you have access to special clean room facilities.
3. The Phase One Product Warranty will be void.

XF Camera System Status



System Status, screen one



System Status, screen two

Checking the XF Camera System Status

You can easily check whether all parts of the XF Camera System is working correctly by tapping on the Battery icon on the Top Touch Screen. The Status screen will show a green checkmark if all is well, a red cross if there is an error, and a white cross is something is missing, like the Viewfinder. Note that you can scroll down with the Front Dial to reveal further information.

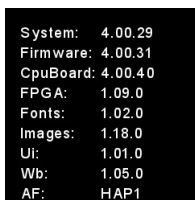

About info, screen one

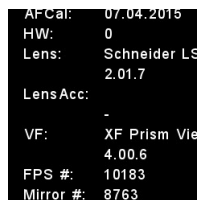

About info, screen two

Checking hardware and software versions

You can access detailed information about both the hardware and software versions on your XF Camera System by pressing the Rear Key and selecting the menu item About. Note that you can scroll down with the Front Dial to reveal further information like the number of shutter release cycles.

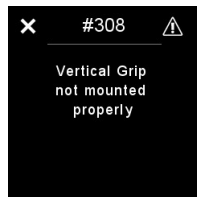

Error message on XF top screen

Error Messages

The XF Camera System has a comprehensive list of error messages that will appear on either the Digital Back screen or the XF Camera top touch screen, depending on the issue that is encountered. The error messages will make sure that you know what to do if some sort of issue arises.

Please note that some of these messages are just notifications that will prompt you to change a user setting or for example remount the Vertical Grip for a better connection. If the error encountered is deemed to be more severe, you will get a message to contact support.

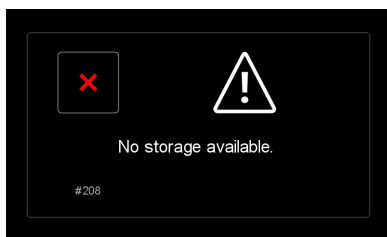

Error message on IQ Digital Back screen

Updating the XF IQ4 System Firmware



Updating Firmware from the IQ4

How to update the XF IQ4 Camera System Firmware

To install a Feature Update, simply download it from the Phase One website and copy the camera package file (with the file extension .fwp) to the root folder of a XQD card.

1. Place the IQ4 on the XF Camera Body.
2. Make sure your installed batteries are fully charged on both the XF Camera Body and IQ4.
3. Insert the XQD card into the IQ4.
4. On IQ4 select Menu > System Settings > Update Firmware.
5. The XF IQ4 Camera System will now update with all relevant firmware updates.

Please do not interrupt the updating process. Should this happen by mistake, the update will fail and you will have to run the update again.

Note that the firmware update process runs an assessment of what firmware files are needed for both the XF Camera and the IQ4. After this assessment is completed, the firmware will be updated on all units with relevant corresponding firmware.

If you disconnect the IQ4 from the XF Camera Body, the firmware will only be updated on the back. This might result in some features not working correctly on the XF Camera with an older firmware and it will be necessary to repeat the firmware update with the IQ4 attached to the XF Camera to enable all features.

Instructions for changing the focusing screen

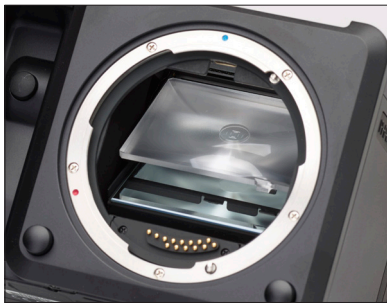

Changing the focusing screen is not a trivial task, and should only be done by an experienced person or a Phase One Service Center.

Note: There are two different procedures for changing the focusing screen, depending on which version of the XF Camera Body you have.

XF Camera bodies with a serial number up to RA003841 require that the focusing screen is changed through the mirror box, while models produced after Nov. 9th 2016 with serial number higher than RA003841 have the focusing screen changed from the top of the XF Camera Body.



Please check the serial number on the bottom of your XF Camera Body, and proceed to the section below that matches your camera version.

WARNING:

Since the focusing screen's surfaces are soft and easily damaged, handle them with care. Never touch the surface with bare fingers. Should dust settle on it, simply blow it away with a blower. If the focusing screen needs cleaning, send it to the nearest authorized Phase One Service Center, instead of attempting to clean it yourself, as it is very delicate. Do not touch the mirror in any way, as its surface is easily damaged.

Instructions for changing the focusing screen for cameras with a serial number up to RA003841.

WARNING:

Before you proceed, make sure that the batteries are fully charged, as the XF Camera System must be powered on throughout the procedure in order to keep the mirror in its down position.



Remove the prism viewfinder or waist level viewfinder from the XF Camera Body. This will make it much easier to see inside the mirror box.

Power on the Digital Back on the XF Camera Body. This will drop the mirror. Remove the lens, and tilt the XF Camera Body backwards with your hand so that you can access the mirror box more easily.

Locate the focusing screen frame release lever, and pull it forward towards you with the supplied tweezers.



This will release the frame, and the focusing screen will drop down in the mirror box.



Carefully remove the focusing screen from its frame by grasping the tab on the edge of the screen with the tweezers. Make sure that you do not scratch or touch the focusing screen or the mirror while removing it from the mirror box.

Instructions continues on next page..



When installing a new focusing screen, pinch the tab of the screen with the tweezers, and place the screen onto the frame. When performed correctly, the focusing screen should easily settle into the frame. Make sure that the tab is on the right side, otherwise the focusing screen will be upside down.



Push the screen frame upwards using the tweezers, while being careful not to touch the focusing screen or the mirror.



Press the frame upwards into position near the release lever until you hear a clicking sound. The screen is now properly installed.

Instructions for changing the focusing screen for XF Cameras with a serial number higher than RA003841.



Remove the digital back and lens from the XF Camera Body. Next, remove the prism viewfinder or waist level viewfinder from the XF Camera.

Locate the focusing screen frame release lever and push it towards the lens mount with the supplied tweezers. This will release the focusing screen and its frame.



Slowly tilt the XF Camera Body backwards until the focusing screen frame tilts out and downwards.



Continue with the tilting movement until the focusing screen follows the frame down, then rest the camera body on its back.



Carefully remove the focusing screen from its frame by grasping the tab on the edge of the screen with the tweezers. Make sure that you do not scratch or touch the focusing screen while doing so.

Instructions continues on next page...



When installing a new focusing screen, pinch the tab of the screen with the tweezers, and place the screen onto the frame and as far as possible into the back end of the frame. Make sure that the tab is on the left side, otherwise the focusing screen will be upside down.



Push the screen frame upwards by pressing the tweezers against the corner of the frame.



Slowly tilt the XF Camera Body to its upright position, while keeping the tweezers against the frame, as shown.



Finally, press the frame downwards close to the screen release lever until you hear a click. The screen is now properly installed.

Learning More

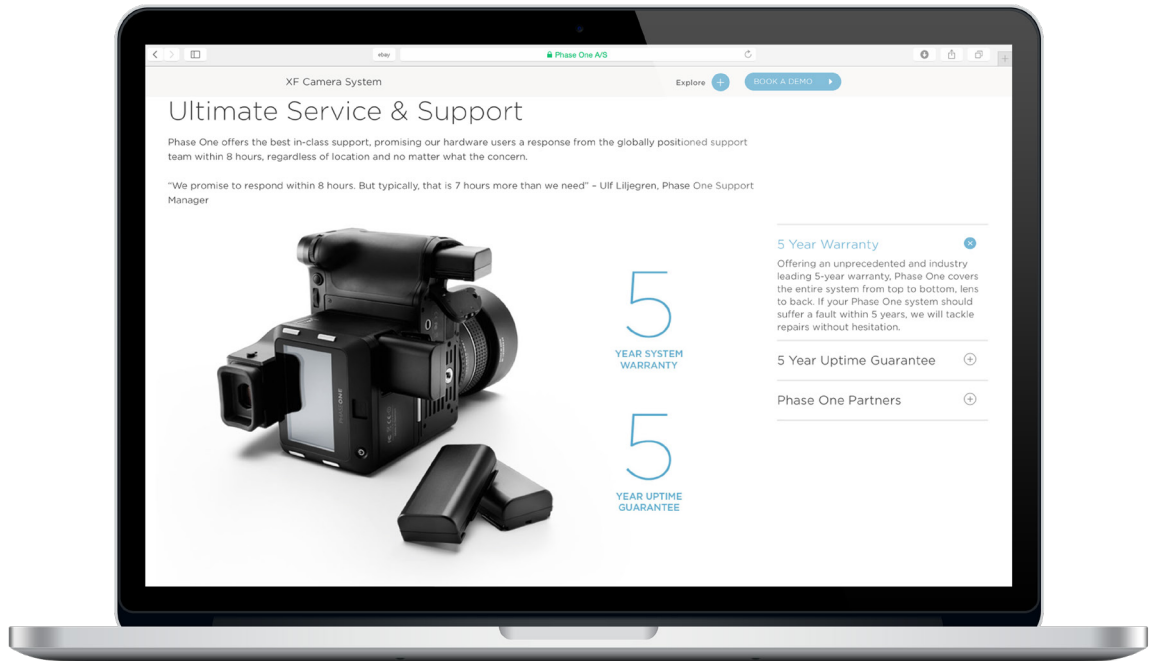

Phase One Customer Service

The Phase One XF Camera System is a high-performance camera designed to endure the rigors of daily professional use under a wide range of environments. However as a precision made optical and mechanical device it should be protected from harsh use, and stored carefully away from extremes of temperature and humidity when not in use.

If the camera is to be stored for an extended period, remove the batteries and store them safely (to prevent shorting and the risk of fire).

Service and Repair

In the event of damage, or if your Phase One equipment requires servicing, please either contact Phase One or a Phase One subsidiary at www.phaseone.com/contact, or reach out to your Phase One Partner at www.phaseone.com/partners

Phase One Technical Support

For support concerning Phase One hardware or Capture One software, including license and activation issues, please contact a member of the Phase One Technical Support team online at: support.phaseone.com

If you are not a registered user, please sign up for timely notifications of firmware and software updates and news of the latest developments. If you have downloaded and registered Capture One previously, you may already have a user account with us.

Phase One Information

For various articles on Phase One products, including system and software documentation, as well as additional resources such as training and tutorials, or the user forum, please consult the online Knowledge Base at support.phaseone.com

Warranty and Uptime Guarantee

Phase One camera systems come with either a 1 Year Classic Warranty, or a 5 Year Warranty and 5 Year Uptime Guarantee. The Warranty options are available at the time of purchase.

5 Year Warranty

Items covered by the 5 Year Warranty and 5 Year Uptime Guarantee:

Phase One XF IQ4 Camera Systems, including:

Phase One IQ4 digital back

Phase One XF Camera Body

XF Prism Viewfinder or XF waist level finder

An optional number of Phase One or Schneider Kreuznach lenses purchased on the same system order.

To activate the Phase One warranty, customers are required to register the product online at www.phaseone.com/My-Pages, or through the registration option when the camera is tethered through Capture One Pro.

See next page for General Conditions.

To activate the Phase One warranty, customers are required to register the product online at www.phaseone.com/My-Pages, or through the registration option when the camera is tethered through Capture One Pro.

General Conditions

Subject to the terms contained here and below, Phase One warrants the mentioned products manufactured by Phase One against defects in materials and workmanship for a period of five (5) years from the date of purchase, covering parts and labor for repairs.

This warranty gives you specific legal rights and you may have other rights that vary from region to region. You are urged to verify whether any additional rights may or may not exist dependent upon your jurisdiction. However, Phase One shall not be liable for consequential damages or loss of data.

During the warranty period, Phase One undertakes at its discretion to repair or replace defective items at no charge to the customer, when such defects are reported to Phase One within the warranty period, and the defective part(s) are returned to Phase One no later than thirty (30) working days after expiry of the warranty period. The customer shall cover the cost of transportation to Phase One and Phase One shall cover the transportation costs for returning the products after repair.

The warranty is limited to the repair or replacement of the faulty part. The warranty does not cover faulty items, where the customer or a third party has attempted without authorization from Phase One to make alterations or repairs, or if the fault is caused by any other circumstances or equipment than the Products themselves or if it is determined that the cause of a failure is the result of customer action or neglect (e.g., dropping or other accident), in which case all costs will be invoiced to the customer. The warranty shall cover only such defects that are due to faulty materials or workmanship. Phase One carries no responsibility for any indirect loss, e.g. consequential loss; loss of profit; loss of data; additional costs etc. as a consequence of deficiencies in Phase One's deliveries.

Phase One shall have no obligation to make repairs or replacements required through normal wear and tear or necessitated in whole or in part by catastrophe, fault or negligence of the user, improper or unauthorized use of or attempt to repair the Products by user or others, or by causes external to the products of part thereof such as, but not limited to, power failure or unusual environmental conditions.

Procedure for Warranty Repairs

Upon experiencing a problem with a Phase One product, an authorized Phase One Partner must be contacted by you to assist you in troubleshooting the problem and if necessary in obtaining a Return Merchandise Authorization (RMA) number from Phase One. Upon receipt by Phase One, Phase One reserves the right to determine and will determine whether the problem lies within the warranty. When you deliver the product to the Phase One Partner, you must bring the original purchase information and serial numbers, including a copy of the sales invoice. The product must be shipped for the attention of the RMA number. Shipping costs to Phase One for RMA warranty repair are borne by you, and any damages in shipping will be billed to you. We recommend that you obtain insurance to cover potential damages during transportation. RMA numbers are only valid for four (4) business days from the date of issuance so you must ship within that period. If a product is returned to Phase One (a) without an RMA number from Phase One; or (b) beyond the four (4) business day period; or (c) without proper packaging, Phase One retains the right to refuse delivery of such return and thereby to void the warranty. Thus, we suggest that you exercise great care in this process. If the product is within warranty, shipping costs in connection with the shipping of the repaired product to you will be borne by Phase One. Otherwise shipping costs are borne by you.

If you are having image quality problems, you should always enclose image samples so that Phase One can determine the reason underlying the problem you believe you are having. All repairs completed within warranty are covered by a normal 90-day guarantee or the balance of the original or extended warranty, whichever is longer. Repairs completed outside warranty are covered by six (6) months warranty on the repaired part.

5 Year Uptime Guarantee

Using the Uptime Guarantee you may request a component loan unit be sent to you within 24 hours*. We will ship the loan unit to you using next business day morning service at our expense.

Phase One allows you one (1) business day to verify the operation of the loan unit and return the defective product to Phase One. If the defective product is not returned within one (1) business day, a penalty fee of USD250 / EUR200 per day for using the loan unit will be invoiced.

Under the 5 Years Warranty and 5 Year Uptime Guarantee, a loan unit (camera body, digital back, lens or viewfinder) will be available as long as the repair lasts.

After the repaired product is returned to you, the loaned product must be returned to Phase One. Instructions for shipping the loaned product will be included with your repaired product. Shipping and insurance costs in connection with the shipping of the repaired product to you will be borne by Phase One. Return shipping costs of the loaned product are borne by you and must be made within 48 hours after delivery of the repaired product. Failure to return the loaned product in a timely manner will result in Phase One invoicing for the loaned product in accordance with our current list price.

*Uptime Guarantee might be impractical to achieve due to heavily

enforced tax regulations, in some countries. Phase One will not be liable for carrying out the Uptime Guarantee shipments to countries where such taxation is enforced. Please ask you Phase One representatives if you are in doubt.

Coverage of Warranty

This Warranty is the complete and exclusive statement of warranty coverage, and it supersedes all prior oral, written, express or implied proposals and communications pertaining to the subject matter hereof. ALL EXPRESSED OR IMPLIED WARRANTIES FOR PHASE ONE PRODUCTS INCLUDING THE IMPLIED WARRANTIES OF MERCHANTABILITY AND FITNESS FOR A PARTICULAR PURPOSE ARE HEREBY WAIVED subject solely to the limited warranties indicated in this document. No warranties, expressed or implied, will apply after the warranty period has lapsed.

Notices

©2019 Phase One A/S. All rights reserved. Made in Denmark.

XF IQ4 User Guide version: 1.04

Feature descriptions in this manual are referring to:
XF Camera System Service Release 4.2 firmware (CameraSystem4.02.x.fwp)
and Capture One 12.0.3

Colorspace images created in CROMiX ColorThink.

Photos by: Søren Jonesen (Photo+Co) and Carsten Esbensen
(Erik Bjørn & Kompagni)

Insert images by Alexander Flemming, Niels V. Knudsen, and Paul Reiffer.

On Liability

The information in this manual is provided "as is".

Under no circumstances, including negligence, shall Phase One be liable for any incidental, special, direct, indirect or consequential damages arising out of or relating to use of the information provided in this guide with or without the software and/or hardware described in the guide.

Phase One reserves the right to change this documents information at any time without prior notice.

All agreements, oral or written, based upon information within this document will be null and void by the replacement or update of this document.

Trademarks and Acknowledgements

Capture One and Phase One are either registered trademarks or trademarks of Phase One A/S in the European Union and/or other countries.

All other trademarks are the property of their respective owners.

This product includes DNG technology under license by Adobe Systems Incorporated.

The Phase One IQ Digital Back firmware includes:

Libjpeg:

=====

This software is based in part on the work of the Independent JPEG Group.

zlib:

=====

Interface of the 'zlib' general purpose compression library

Copyright (C) 1995-2012 Jean-loup Gailly and Mark Adler

This software is provided 'as-is', without any express or implied warranty. In no event will the authors be held liable for any damages arising from the use of this software.

Permission is granted to anyone to use this software for any purpose, including commercial applications, and to alter it and redistribute it freely, subject to the following restrictions:

1. The origin of this software must not be misrepresented; you must not claim that you wrote the original software. If you use this software in a product, an acknowledgment in the product documentation would be appreciated but is not required.
2. Altered source versions must be plainly marked as such, and must not be misrepresented as being the original software.
3. This notice may not be removed or altered from any source distribution.

Jean-loup Gailly Mark Adler

jloup@gzip.org madler@alumni.caltech.edu177

FCC Regulations:

§ 15.19 (a)(3)

This device complies with part 15 of the FCC Rules. Operation is subject to the following two conditions: (1) This device may not cause harmful interference, and (2) this device must accept any interference received, including interference that may cause undesired operation.

§ 15.21

Changes or modifications not expressly approved by the party responsible for compliance could void the user's authority to operate the equipment.

§ 15.105 (b)

This equipment has been tested and found to comply with the limits for a Class B digital device, pursuant to part 15 of the FCC Rules. These limits are designed to provide reasonable protection against harmful interference in a residential installation. This equipment generates, uses and can radiate radio frequency energy and, if not installed and used in accordance with the instructions, may cause harmful interference to radio communications. However, there is no guarantee that interference will not occur in a particular installation. If this equipment does cause harmful interference to radio or television reception, which can be determined by turning the equipment off and on, the user is encouraged to try to correct the interference by one or more of the following measures:

- Reorient or relocate the receiving antenna.
- Increase the separation between the equipment and receiver.
- Connect the equipment into an outlet on a circuit different from that to which the receiver is connected.
- Consult the dealer or an experienced radio/TV technician for help.

§ 15.407 (e)

Operation on the 5.15-5.25 GHz frequency band is restricted to indoor use only. The FCC requires indoor use for the 5.15-5.25 GHz band to reduce the potential for harmful interference to co-channel Mobile Satellite Systems.

§ 2.1093

RF Exposure Information (SAR)

This device is designed and manufactured not to exceed the emission limits for exposure to radio frequency (RF) energy set by the Federal Communications Commission of the U.S. Government. The exposure standard for wireless devices employs a unit of measurement known as the Specific Absorption Rate (SAR). The SAR limit adopted by the FCC is 1.6W/kg for an uncontrolled environment. Tests for SAR are conducted using standard operating positions accepted by the FCC with the device transmitting at its highest certified power level in all tested frequency bands. The FCC has granted an Equipment Authorization for this device with all reported SAR levels evaluated as in compliance with the FCC.

IQ3 Digital Back FCC ID: RYK WUBR507N

IQ4 Digital back FCC ID: XO2SBP209A

XF Camera contains Profoto Air Module FCC ID: W4G-RMI

RF exposure guidelines.

Although the SAR is determined at the highest certified power level, the actual SAR level of the device while operating can be well below the maximum value. This is because the device is designed to operate at multiple power levels so as

